



AUTOMOTIVE LIGHTING

Ormalight bv
P.O. Box 365
NL - 5900 AJ Venlo
The Netherlands

T +31 (0)77 - 356 01 80
F +31 (0)77 - 351 44 99
info@ormalight.com
www.ormalight.com

Ormalight Romania srl
Lamp plant since 1936
No. 1, Garii Street
RO - 135100 Fieni
Dâmbovita District
ROMANIA

T +40 (0)245 - 606 031
F +40 (0)245 - 606 032
ormalight@selum.ro
www.ormalight.selum.ro



Our general terms and conditions of deliveries and/or services are applicable to all offers and agreements. Ormalight® will send you a free copy at your request. The data mentioned in this copy are provided for information only. Ormalight® reserves the right to implement any changes it may deem necessary. Subject to alterations.



Lamp	Base	Page
INDEX	LAMP OVERVIEW	
COMPANY INTRODUCTION		
BASES	OVERVIEW	
BULBS APPLICATION OVERVIEW (CAR)		
BULBS APPLICATION OVERVIEW (TRUCK)		
BULBS APPLICATION OVERVIEW (MOTORCYCLE)		
HALOGEN HEADLIGHT LAMPS		
H1 HALOGEN	P14,5s	
H2 HALOGEN	X511	
H3 HALOGEN	PK22s	
H4 HALOGEN	P43t	
H4 HALOGEN	P45t	
H4 HALOGEN YELLOW	P43t	
H5 HALOGEN	P45t	
H6 HALOGEN	BAX9s	
H7 HALOGEN	PX26d	
H8 HALOGEN	PGJ19-1	
HB8 HALOGEN	PGJ19-1	
H9 HALOGEN	PGJ19-5	
H9B HALOGEN	PGJ19-5	
H10 HALOGEN	PY20d	
H11 HALOGEN	PGJ19-2	
H11B HALOGEN	PGJ19-2	
H12 HALOGEN	PZ20d	
H13 HALOGEN	P26,4t	
H15 HALOGEN	PGJ23t-1	
H16 HALOGEN	PGJ19-3	
H21 HALOGEN	BAY9s	
HALOGEN INFRARED	PX20d/PX22d	
H.I.D. LAMPS / XENON HEADLIGHT	P32d-/PK32d-	
AMERICAN HALOGEN HB1	P29	
AMERICAN HALOGEN HB2/H4	P43t	
AMERICAN HALOGEN HB3	P20d	
AMERICAN HALOGEN HB3A	P20d	
AMERICAN HALOGEN HB4	P22d	
AMERICAN HALOGEN HB4A	P22d	
AMERICAN HALOGEN HB5	PX29t	
AMERICAN HALOGEN HB7	PX29t	
AMERICAN HALOGEN H27W/1	PG13	
AMERICAN HALOGEN H27W/2	PGJ13	
AMERICAN INCANDESCENT S25	W2,5x16q	
SYMMETRICAL AND SYMMETRICAL LAMPS		
ASYMMETRICAL HEADLIGHT	P45t	
SYMMETRICAL HEADLIGHT	BA20d	
FRENCH SOCKET 3 PIN SYMMETRIC	BA21s	
FRENCH SOCKET 3 PIN SYMMETRIC	BA21d	
SINGLE AXIAL HEADLIGHT	BA20d	
SINGLE AXIAL HEADLIGHT	BA20s	
AXIAL FILAMENT HEADLIGHT	BA15s	
AXIAL FILAMENT HEADLIGHT	BA15d	

Lamp	Base	Page
STOP / PARKING / REAR (TAIL) / FLASHER LAMPS		
SINGLE FILAMENT	BA15s	
SINGLE FILAMENT S25	BA15s	
SINGLE FILAMENT S25	BA15d	
SINGLE FILAMENT S25	BAU15s	
DOUBLE FILAMENT S25	BA15d	
DOUBLE FILAMENT S25	BAY15d	
DOUBLE FILAMENT S25	BAZ15d	
PARKING/TAIL/INDICATOR/WARNING/INTERIOR G-18	BA15s	
PARKING/TAIL/INDICATOR/WARNING/INTERIOR G-18	BA15d	
PARKING/TAIL/INDICATOR/WARNING/INTERIOR T-16	BA15s	
PARKING/TAIL/INDICATOR/WARNING/INTERIOR T-16	BA15d	
PREFOCUS SYMMETRIC	PK22s	
PREFOCUS SYMMETRIC	P22d	
SPECIAL AUTO LAMP	P36s	
DASHBOARD / PARKING / INTERIOR LAMPS		
DASHBOARD	BA7s	
DASHBOARD	BA9s	
DASHBOARD / PARKING	BA9s	
WEDGE BASE T5	W2x4,6d	
WEDGE BASE T10	W2,1x9,5d	
WEDGE BASE T15	W2,1x9,5d	
WEDGE BASE T20	W3x16d/q	
INTERIOR / FESTOON LAMPS		
WIRE ENDED		
INTERIOR ILLUMINATION G-11	BA9s	
INTERIOR ILLUMINATION G-15	BA9s	
FESTOON SV6	SV6	
FESTOON SV7	SV7	
FESTOON SV7/8	SV7/8	
FESTOON SV8,5/8	SV8,5/8	
BICYCLE / SCOOTER / MOTORCYCLE LAMPS		
BICYCLE HEADLAMP G-11	BA9s	
BICYCLE HEADLAMP G-15	BA9s	
BICYCLE AND SCOOTER REAR LAMP G-11	E10/13	
MOTORCYCLE AND BICYCLE HEADLAMP G-15	E10/13	
BICYCLE HEADLAMP HALOGEN	E10/13	
MOPED HEADLAMP HALOGEN	PX13,5s	
MOTORCYCLE LAMP	P26s	
MOTORBIKE AND MOTORCYCLE HEADLAMP HALOGEN	P26s	
MOTORCYCLE HALOGEN HEADLAMP	P36t	
MOTOR AND MOTORCYCLE	PX15d	
MOTOR AND MOTORCYCLE HEADLIGHT	P15d	
MOTOR AND MOTORCYCLE HEADLIGHT	BA15d	
MOTOR AND MOTORCYCLE KRYPTON	PX15d-3	
HALOGEN STOP - REAR - FLASHER LAMPS		
HALOGEN STOP/REAR AND FLASHER	BA9s	
HALOGEN STOP/REAR AND FLASHER	BAY9s	
HALOGEN STOP/REAR AND FLASHER	BA15s	
DISTANCE KEY	MG/MF	



Lamp	Base	Page
WEDGE BASE LAMPS WITH PLASTIC SOCKET / PLASTIC CAP		
WEDGE BASE LAMP PLASTIC CAP	B8,3d	
WEDGE BASE LAMP PLASTIC CAP	B8,5d	
WEDGE BASE LAMP PLASTIC CAP	BX8,5d	
WEDGE BASE LAMP PLASTIC CAP	B8,7d	
WEDGE BASE LAMP PLASTIC CAP	BAX10s	
WEDGE BASE LAMP PLASTIC CAP	BAX10d	
WEDGE BASE LAMP PLASTIC CAP	BAX10y	
WEDGE BASE LAMP PLASTIC CAP	BAX8,4d	
WEDGE BASE LAMP PLASTIC CAP	B12,3d	
WEDGE BASE LAMP PLASTIC CAP	B10d	
WEDGE BASE LAMP PLASTIC CAP	B8,4d	
WEDGE BASE LAMP PLASTIC CAP	BX8,4d	
FORKLIFT LAMPS		
FORK LIFT LAMP G-15	BA9s	
FORK LIFT LAMP S25	BA15s	
FORK LIFT LAMP S25	BA15d	
FORK LIFT LAMP T7	BA7s	
FORK LIFT LAMP T8,8	BA9s	
FORK LIFT LAMP G-18	BA15s	
FORK LIFT LAMP G-18	BAY15d	
FORK LIFT LAMP HALOGEN	PK22s	
FORK LIFT LAMP S25	BAY15d	
FORK LIFT LAMP S36	BA20s	
FORK LIFT LAMP S25	BA20d	
FORK LIFT LAMP S36	BA20d	
SPARE KITS		
SPARE KITS AUTOMOTIVE		
WORK LAMPS (RC) FOR GARAGES/WORKSHOPS		
WORKLAMPS (RC)	E27	
BOAT AND NAVIGATION LAMPS		
BOAT AND NAVIGATION T26	BAY15d	
BOAT AND NAVIGATION S45	BAY15d	
BOAT AND NAVIGATION G36	BAY15d	
BOAT AND NAVIGATION T39	BA22d	
BOAT AND NAVIGATION T39	E27	
BOAT AND NAVIGATION T38	P28s	

GB We cordially welcome you to Ormalight SRL – Romania, one of the last independent lighting factories in Europe, which was founded in 1938, that means over 80 years' experience in production of lamps. Today there is production of: Incandescent Household-, ECO Halogen-, LED Filament lamps and a complete wide range of Automotive lamps. Our goods find their way in the whole EUROPEAN, AFRICAN, MIDDLE EAST and SOUTH AMERICAN markets to the importers and main distributors.

ORMALIGHT SRL is selling and shipping their goods under different brands to OEM customers and main distributors which are big enough to have their own brand and packaging. The headquarters are situated in VENLO - The Netherlands, with own branches in Belgium, Germany, Italy etc. We dispose of a professional commercial network in most EU countries, besides our business partners in AFRICA, MIDDLE EAST AND SOUTH AMERICA and other overseas importers.

Because the daily traffic conditions demand an efficient and reliable vehicle lighting, our lighting can stand for a high reliability and safe driving conditions. Since many years, our passion for lighting has driven us to produce and distribute worldwide top quality bulbs, which are in conformity with the strict standards of the automotive industry. Our lamps are compliant with ECE R37/03 standards and have the "E"-mark approvals.

Ormalight also supplies miniature signalling lamps, front and tail lamps, such as are used for bicycles and scooters. Additionally, we distribute forklift lamps, workshop lamps and navigation or boat lamps.

We guarantee the highest level of customer satisfaction, thanks to our contemporarily manufacturing, our well organized logistics and our carefully selected distributors' network. One of the strong points is the flexibility that Ormalight SRL is having to produce private labels and OEM brands.

Our series of halogen headlights have been expanded with the latest references. Special attention deserve our Heavy Duty (HD) lamps, specially designed and produced to have resistance against vibrations and shocks. Long Life lamps (LL) have double life time compared to the normal ranges.

Recently added to our sales programme the SUPREME PLUS halogen lamps with 30%, 50% and even up to 100% extra light.

And for the latest product, we recommend you our HID headlights (High-Intensity Discharge), also called Xenon Headlights (page 20). Producing high quality automotive bulbs is an art. Innovation and commitment are the main elements of our well structured organisation. The use of HQ raw materials, our duly controlled producing processes and our skilled sales team secure our target: manufacturing a stable brand for road safety and great visibility.

Our 5 main keywords to help realise this are:

- 1) Quality
- 2) Durability
- 3) Reliability
- 4) Flexibility
- 5) Personalised service

For more information, please visit our website: www.ormalight.com/autolamps or contact us by email, fax or phone. We are pleased to be at your service.

One thing is unmistakable : with Ormalight® products, you are 100% sure to have choosen the right lighting solution for your needs!



FR Bienvenue chez Ormalight SRL - Roumanie, l'une des dernières usines indépendantes de fabrication de systèmes d'éclairage en Europe. Fondée en 1938, elle possède plus de 80 années d'expérience dans le domaine de la production de lampes. Aujourd'hui, l'usine fabrique des lampes à incandescence à usage domestique, des lampes halogènes ECO, des lampes à LED à filament et un éventail complet de lampes automobiles. Nos produits sont expédiés à travers l'ensemble des marchés d'EUROPE, d'AFRIQUE, du MOYEN-ORIENT et d'AMÉRIQUE DU SUD jusqu'aux importateurs et aux principaux distributeurs.

ORMALIGHT SRL vend et livre ses produits sous différentes marques à des clients équipementiers (OEM) et de grands distributeurs suffisamment importants pour disposer de leurs propres marques et emballages. Notre siège est situé à VENLO aux Pays-Bas et nous possédons des filiales en Belgique, en Allemagne, en Italie, etc.

Nous disposons d'un réseau commercial professionnel dans la plupart des pays de l'UE et nous pouvons compter sur des partenaires commerciaux en AFRIQUE, au MOYEN-ORIENT et en AMÉRIQUE DU SUD, ainsi que sur d'autres importateurs à l'étranger.

Comme les conditions de circulation quotidiennes exigent des véhicules dotés d'un système d'éclairage efficace et fiable, nous proposons des phares offrant un niveau de fiabilité élevé et toute la sécurité de conduite nécessaire. Notre passion pour l'éclairage nous pousse depuis de nombreuses années à produire et à distribuer dans le monde entier des lampes de qualité optimale, conformes aux normes strictes de l'industrie automobile. Nos lampes répondent aux exigences de la norme ECE R37/03 et bénéficient des autorisations de la marque «E».

Ormalight fournit également des feux avant et arrière ainsi que des feux de signalisation miniatures semblables à ceux qui équipent les vélos et les scooters. Nous distribuons aussi des lampes de chariot élévateur, des lampes d'atelier ainsi que des lampes de navigation ou de bateau.

Nous garantissons le plus haut niveau de satisfaction des consommateurs grâce à nos unités de production modernes, à l'excellente organisation de notre chaîne logistique et à notre réseau de distributeurs triés sur le volet. L'un des points forts d'Ormalight SRL réside dans la flexibilité dont nous faisons preuve pour fabriquer des produits de marque de distributeur et d'équipementier.

Notre série de phares halogènes a été élargie pour inclure les références les plus récentes. Nos lampes ultra-résistantes Heavy Duty (HD), spécialement conçues et fabriquées pour résister aux chocs et aux vibrations, méritent une attention particulière. Les lampes Long Life (LL) à longue durée de vie durent deux fois plus longtemps que les lampes normales.

Les lampes halogènes SUPREME PLUS, qui produisent 30 %, 50 % voire jusqu'à 100 % de lumière en plus, ont été récemment ajoutées à notre programme de vente.

Et pour le tout dernier produit, nous vous recommandons notre phare à décharge haute intensité (DHI) également appelé phare au xénon (page 20). La fabrication de lampes automobiles de haute qualité est un art. L'innovation et l'engagement constituent les principaux éléments de notre organisation parfaitement structurée.

L'utilisation de matières premières de qualité supérieure, nos processus de production rigoureusement contrôlés et notre force de vente compétente nous permettent d'atteindre notre objectif: fabriquer une marque stable étudiée pour garantir la sécurité sur la route et une visibilité exceptionnelle.

Nous nous basons sur cinq mots-clés pour y parvenir:

- 1) Qualité
- 2) Longévité
- 3) Fiabilité
- 4) Flexibilité
- 5) Service personnalisé

Pour de plus amples informations, visitez notre site : www.ormalight.com/autolamps ou prenez contact avec nous par e-mail, fax ou téléphone. Nous sommes heureux d'être à votre service.

Une chose est certaine: avec les produits Ormalight®, vous êtes absolument sûr d'avoir choisi la solution d'éclairage parfaitement adaptée à vos besoins!

D Wir heißen Sie herzlich willkommen bei Ormalight SRL - Romania, einer der letzten unabhängigen Beleuchtungsfabriken in Europa, die 1938 gegründet wurde und mehr als 80 Jahre Erfahrung in der Herstellung von Leuchtmitteln hat. Hier wird heute Folgendes produziert: Haushaltsglühlampen, ECO Halogenlampen, LED-Glühlampen und ein umfassendes Sortiment an Fahrzeuglampen. Unsere Produkte finden ihren Weg in die Märkte in EUROPA, AFRIKA, SÜDAMERIKA und im NAHEN OSTEN zu den Importeuren und Hauptvertriebshändlern.

ORMALIGHT SRL verkauft und liefert seine Waren unter verschiedenen Marken an OEM-Kunden und Hauptvertriebshändler, die groß genug sind, dass sie ihre eigene Marke und Verpackung haben. Das Hauptquartier befindet sich in VENLO in den Niederlanden mit eigenen Zweigstellen in Belgien, Deutschland, Italien etc.

Wir verfügen über ein professionelles kommerzielles Netzwerk in den meisten EU-Ländern, neben unseren Geschäftspartnern in AFRIKA, SÜDAMERIKA und dem NAHEN OSTEN und weiteren Importeuren im Ausland.

Da die täglichen Verkehrsbedingungen effiziente und zuverlässige Fahrzeugbeleuchtung erfordern, steht unsere Beleuchtung für hohe Verlässlichkeit und Fahrsicherheit. Seit vielen Jahren treibt uns unsere Leidenschaft für Beleuchtung dazu an, weltweit hochwertige Glühlampen zu produzieren, die den strengen Normen der Automobilindustrie entsprechen. Unsere Lampen entsprechen den ECE R37/03-Regelungen und besitzen die „E“-Zeichen Zulassungen.

Ormalight liefert auch Miniatur-Signalleuchten, Front- und Rückleuchten, wie sie für Fahrräder und Motorroller verwendet werden. Außerdem vertreiben wir Leuchten für Gabelstapler, Werkstattleuchten und Navigations- oder Schiffs Lampen.

Dank unserer modernen Produktion, einer bestens organisierten Logistik und unserem sorgfältig ausgewählten Vertriebshändlernetzwerk können wir höchste Kundenzufriedenheit garantieren. Eine unserer Stärken liegt in der Flexibilität, mit der Ormalight SRL Eigen- und OEM-Marken herstellen kann.

Unsere Halogenscheinwerferserie wurde um die neusten Empfehlungen erweitert. Besonders zu erwähnen sind hier unsere Heavy Duty (HD) Lampen, die speziell entwickelt wurden, um Vibrationen und Erschütterungen standzuhalten. Long Life Lampen (LL) punkten im Vergleich zu herkömmlichen Varianten mit der doppelten Lebensdauer.

Vor kurzem haben wir unser Verkaufsprogramm um die SUPREME PLUS Halogenlampen erweitert, mit 30 %, 50 % und sogar bis zu 100 % mehr Licht.

Und für das neuste Produkt empfehlen wir Ihnen unsere HID-Scheinwerfer (High-Intensity Discharge), auch Xenon-Scheinwerfer genannt (Seite 20).

Qualitativ hochwertige Fahrzeuglampen zu produzieren ist eine Kunst. Innovation und Engagement sind die wesentlichsten Elemente unserer gut strukturierten Organisation.

Die Nutzung von hochwertigen Rohstoffen, unsere ordnungsgemäß kontrollierten Produktionsverfahren und unser kompetentes Verkaufsteam stehen Garant für unser Ziel: Den Aufbau einer soliden Marke für Straßensicherheit und maximale Sichtbarkeit.

5 wichtige Schlüsselwörter helfen uns dabei:

- 1) Qualität
- 2) Langlebigkeit
- 3) Verlässlichkeit
- 4) Flexibilität
- 5) Personalisierter Service

Für weitere Informationen besuchen Sie bitte unsere Website: www.ormalight.com/autolamps oder kontaktieren uns per E-Mail, Fax oder Telefon. Wir stehen Ihnen gerne zur Seite.

Eines ist sicher: bei Ormalight® Produkten wissen Sie zu 100%, dass Sie die richtige Beleuchtungslösung für Ihre Anforderungen gewählt haben!



E Le damos una cordial bienvenida a Ormalight SRL – Romania, una de las últimas fábricas de iluminación independientes de Europa. Fundada en 1938, contamos con más de 80 años de experiencia en la producción de lámparas. Actualmente, producimos: iluminación incandescente para el hogar, ECO halógenos, bombillas de filamentos LED, así como un amplio y completo abanico de lámparas para automóviles. Nuestros productos llegan a los importadores y principales distribuidores de los mercados de EUROPA, AFRICA, ORIENTE MEDIO y SUDAMÉRICA.

ORMALIGHT SRL vende y envía sus productos bajo distintas marcas a distribuidores y fabricantes de equipamiento original (OEM) que sean lo suficientemente importantes como para contar con su propia marca y embalaje. Nuestra sede central está en VENLO, Países Bajos, y contamos con sucursales en Bélgica, Alemania, Italia, etc.

Disponemos de una red comercial profesional que abarca la mayoría de países de la UE. También tenemos socios comerciales en AFRICA, ORIENTE MEDIO Y SUDAMÉRICA, aparte de otros importadores internacionales.

Las condiciones actuales del tráfico requieren que los vehículos dispongan de una iluminación eficiente y de confianza. Por ello, nuestra iluminación está diseñada para ofrecer unas condiciones de conducción muy seguras y fiables. Desde hace muchos años, nuestra pasión por la iluminación nos ha llevado a producir y distribuir a nivel internacional bombillas de alta calidad que cumplan con los estrictos estándares de la industria de la automoción. Nuestras lámparas cumplen con la normativa ECE R37/03 y cuentan con el marcado E.

Ormalight también suministra lámparas de señalización en miniatura y luces delanteras y traseras como las que utilizan las bicicletas o los escúteres. Además, distribuimos lámparas para montacargas y talleres, así como luces de navegación o para barcos.

Gracias a nuestra moderna fabricación, a nuestra logística bien organizada y a nuestra red de distribuidores cuidadosamente seleccionados, podemos garantizar el más alto nivel de satisfacción de nuestros clientes. Uno de nuestros puntos fuertes de Ormalight SRL es la flexibilidad para producir marcas blancas y de OEM.

Gracias a nuestros últimos avances, hemos ampliado nuestra serie de faros halógenos. Merecen especial atención nuestras lámparas para tareas pesadas (TP), diseñadas y fabricadas para resistir vibraciones y golpes, y las lámparas de larga duración (LD), cuya vida útil es del doble que las de gama básica.

Recientemente, también hemos añadido a nuestro programa de ventas las lámparas halógenas SUPREME PLUS, que cuentan con un extra de luz del 30%, el 50% e incluso del 100%.

Por último, le recomendamos nuestros faros HID (alta intensidad de descarga), también conocidos como faros de xenón (página 20). Fabricar bombillas de alta calidad para automóviles es un arte. La innovación y el compromiso son los pilares básicos de nuestra bien estructurada organización.

El uso de materias primas de alta calidad, un proceso de producción debidamente controlado y un experimentado equipo de ventas nos permiten alcanzar nuestro objetivo: fabricar una marca estable que proporcione gran visibilidad y seguridad en la carretera.

Los 5 conceptos clave que nos ayudan a conseguirlo son:

- 1) Calidad
- 2) Durabilidad
- 3) Fiabilidad
- 4) Flexibilidad
- 5) Servicio personalizado

Visite nuestra página web para obtener más información:

www.ormalight.com/autolamps o póngase en contacto con nosotros por correo electrónico, fax o teléfono. Estamos aquí para servirle.

De una cosa no cabe duda: con los productos Ormalight® puede estar 100% seguro de haber escogido la solución de iluminación que mejor se adapta a sus necesidades.

I Abbiamo il piacere di presentarvi Ormalight SRL – Romania, una delle ultime fabbriche di illuminazione indipendenti in Europa. E' stata fondata nel 1938, ciò significa un'esperienza oltre 80 anni di nella produzione di lampade. Ancora oggi produciamo: Lampade ad incandescenza, ECO alogene, Lampade filamento a LED e una completa gamma di lampade Automotive. I nostri prodotti sono destinati ai mercati di tutta EUROPA, AFRICA, MEDIO ORIENTE e SUD AMERICA attraverso importatori ed i principali distributori.

ORMALIGHT SRL vende le proprie merci con diversi marchi ai clienti OEM e distributori abbastanza grandi per avere il proprio marchio e packaging. La sede è situata a VENLO in Olanda con filiali proprie in Belgio, Germania, Italia ecc. Disponiamo di una rete commerciale professionale nella maggior parte dei paesi UE, oltre ai nostri partner commerciali in AFRICA, MEDIO ORIENTE e SUD AMERICA ed altri importatori oltremare.

Le intense condizioni di traffico richiedono un'illuminazione del veicolo sempre più efficiente e affidabile, le nostre lampade garantiscono un'elevata affidabilità e condizioni di guida sicure. Da molti anni la nostra passione per l'illuminazione ci ha spinto a produrre e distribuire lampadine di qualità superiore in tutto il mondo, che sono conformi ai rigorosi standard dell'industria automobilistica. Le nostre lampade sono conformi agli standard ECE R37/03 ed hanno le approvazioni E MARK.

Ormalight produce anche lampade di segnalazione in miniatura, lampade per biciclette e scooter, carrelli elevatori, officina, navigazione e barche.

Noi garantiamo il massimo livello di soddisfazione del cliente, grazie alla produzione aggiornata, alla logistica ben organizzata e distributori accuratamente selezionati. Uno dei punti di forza di Ormalight è la flessibilità nel produrre etichette personalizzate e marchi OEM.

La nostra gamma di lampadine alogene è stata recentemente ampliata. Particolare attenzione meritano le nostre lampade Heavy Duty (HD), studiate e prodotte per avere una maggiore resistenza contro urti e vibrazioni. Lampade di Long Life (LL) hanno una durata di vita doppia rispetto alle gamme normali.

Recentemente abbiamo aggiunto alla nostra gamma le lampade alogene SUPREME PLUS con 30%, 50% e anche fino al 100% di luce in più.

Tra gli ultimi prodotti inseriti vi consigliamo di provare le nostre lampade HID (High Intensity Discharge) chiamate anche Xenon (page 20).

La produzione di lampadine Automotive di alta qualità è un'arte. L'innovazione e l'impegno sono gli elementi principali della nostra organizzazione. L'uso di materie prime di alta qualità insieme ai rigorosi controlli di produzione consentono al nostro team di raggiungere i risultati che ci siamo prefissati.

Le nostre 5 principali parole chiave per realizzare questo scopo sono:

- 1) Qualità
- 2) Durata
- 3) Affidabilità
- 4) Flessibilità
- 5) Servizio personalizzato

Per ulteriori informazioni, si prega di visitare il nostro sito:

www.ormalight.com/autolamps o contattarci via e-mail, fax o telefono. Saremmo lieti di essere al vostro servizio.

Una cosa è inconfondibile: con i prodotti Ormalight®, sei sicuro di avere scelto la soluzione giusta per le vostre esigenze al 100%.



HIGH BEAM / LOW BEAM

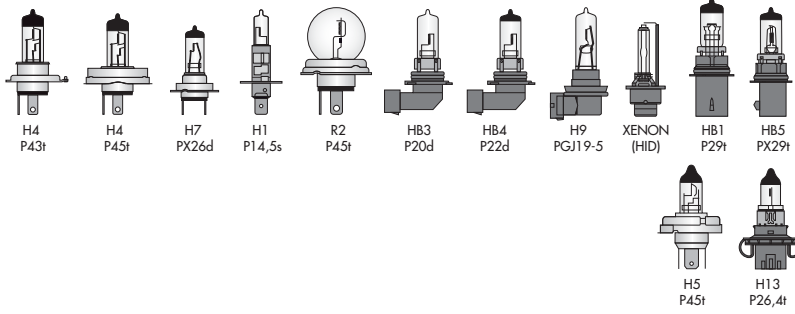

PARKING LIGHT

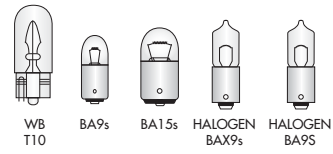

FRONT FOG LIGHT

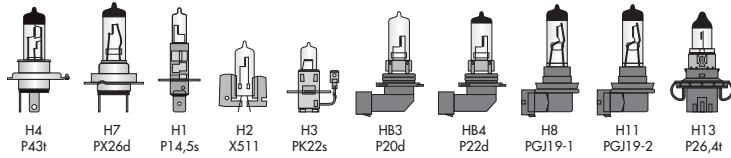

FLASHER WARNING LIGHT

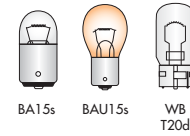

INTERIOR LIGHT

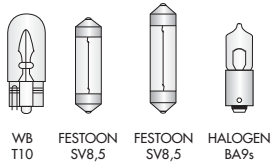

SIDE FLASHER (BLINKER)

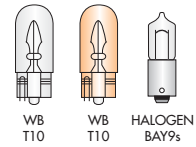

DASHBOARD LIGHT

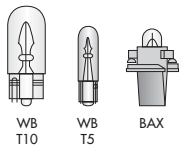

GLOVE COMPARTMENT LIGHT

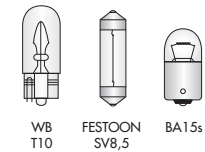

TRUNK LIGHT

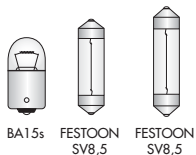

REAR FLASHER / REAR SIGNAL WARNING LIGHT

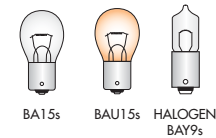

PARKING LIGHT

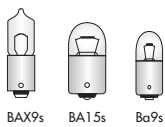

STOP LIGHT LEFT/RIGHT

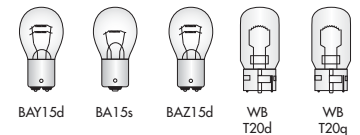

MIDDLE STOP LIGHT

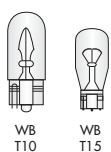

LICENCE PLATE LIGHT

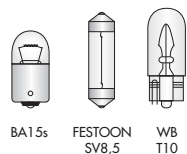

REAR FOG LIGHT

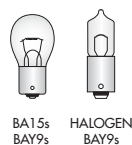

BACKUP LIGHT

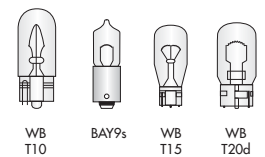

TRUCK BULBS 24V OVERVIEW



HIGH BEAM / LOW BEAM

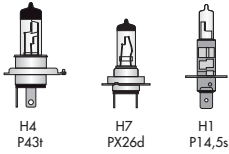

FRONT FOG LIGHT

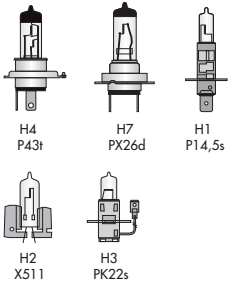

DASHBOARD LIGHT

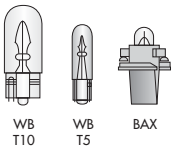

SIDE LIGHT

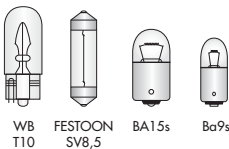

PARKING LIGHT



REAR FOG LIGHT



LICENCE PLATE LIGHT

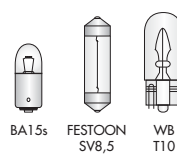

BACKUP LIGHT



STOP LIGHT LEFT / RIGHT

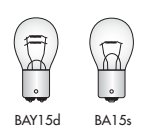

PARKING LIGHT

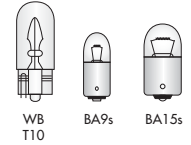

REAR FLASHER / WARNING LIGHT

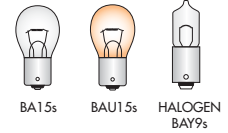

INTERIOR LIGHT

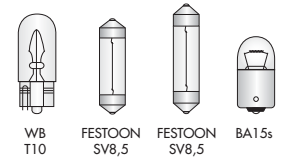

SIDE LIGHT

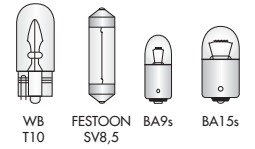

REAR FLASHER REARTURN SIGNAL WARNING LIGHT

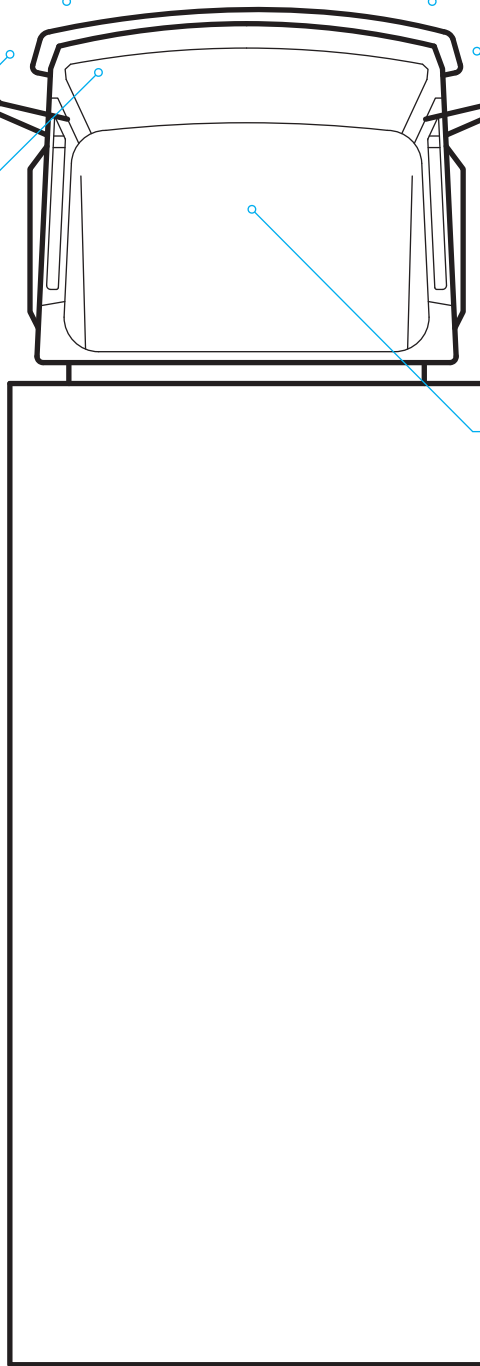
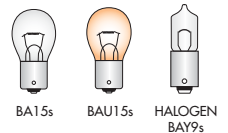



HEADLIGHT (LOW BEAM / FULL BEAM)

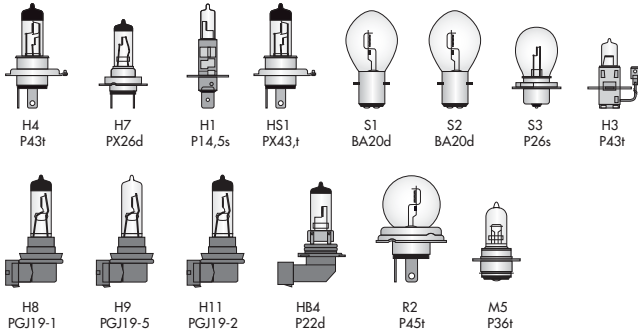

FRONT INDICATOR / BLINKING / FLASHER LIGHT

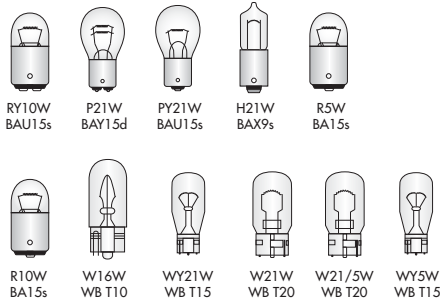

REAR INDICATOR / BLINKING / FLASHER LIGHT

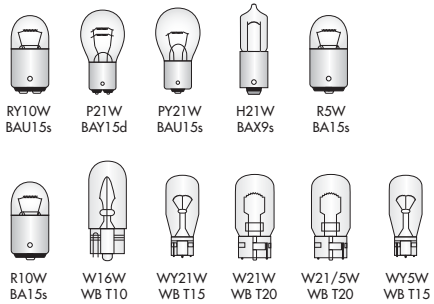

DASHBOARD LIGHT / INSTRUMENT LIGHT

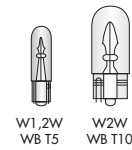

PARKING LIGHT

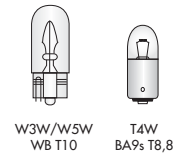

DASHBOARD LIGHT / INSTRUMENT LIGHT

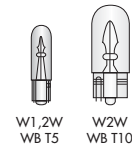

STOP / BREAK / REVERSING LIGHT

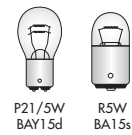

LICENCE PLATE LIGHT

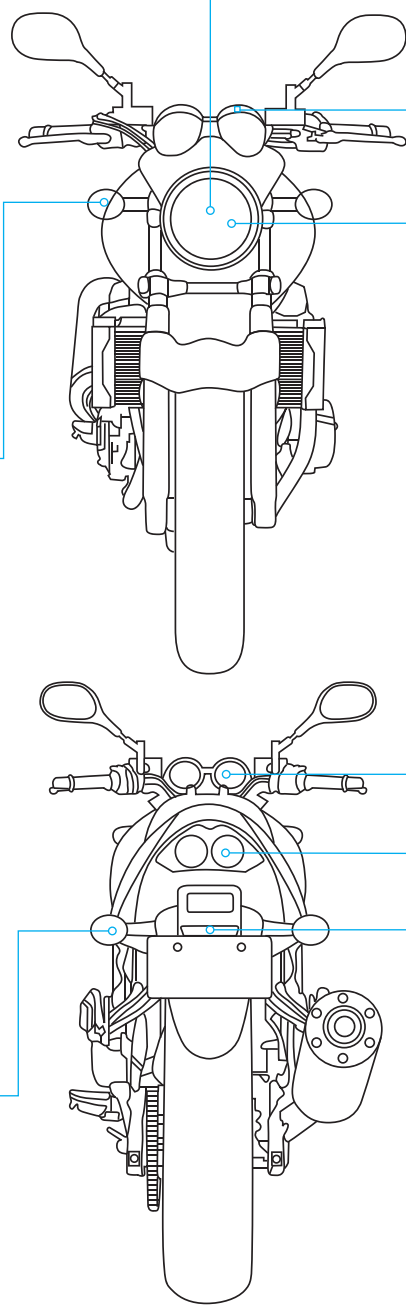
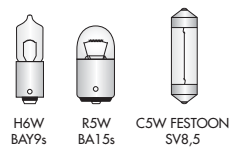



Folding Carton Box

Material: carton/paper
Contents: 1 piece in a box



Folding Carton Box

Material: carton/paper
Contents: 10 pieces in a box











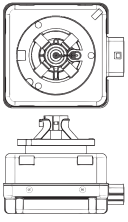
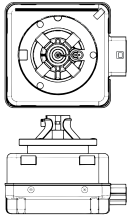
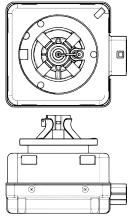
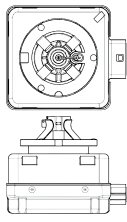
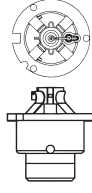
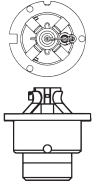
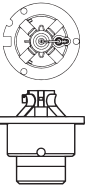
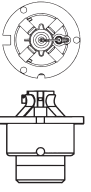

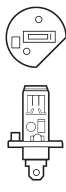

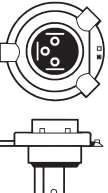
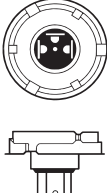
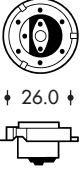

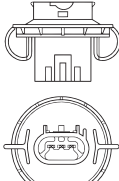
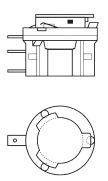
Single & Twin blister card

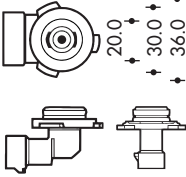
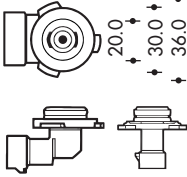
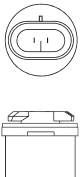
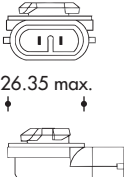



































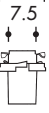









Material: carton/plastic
Contents: 1 or 2 pieces on a card





 <p>↑ 25.0 max. ↑ ↑ 35.0 ↑</p> <p>PK32d-2</p>	 <p>↑ 25.0 max. ↑ ↑ 35.0 ↑</p> <p>PK32d-5</p>	 <p>↑ 25.0 max. ↑ ↑ 35.0 ↑</p> <p>PK32d-3</p>	 <p>↑ 25.0 max. ↑ ↑ 35.0 ↑</p> <p>PK32d-6</p>	 <p>↑ 32.0 ↑</p> <p>P32d-2</p>	 <p>↑ 32.0 ↑</p> <p>P32d-5</p>
 <p>↑ 32.0 ↑</p> <p>P32d-3</p>	 <p>↑ 32.0 ↑</p> <p>P32d-6</p>	 <p>↑ 14.5 ↑</p> <p>P14,5s</p>	 <p>↑ 14.5 ↑</p> <p>PX14,5s</p>	 <p>↑ 22.0 ↑</p> <p>PK22s</p>	 <p>↑ 43.0 ↑</p> <p>P43t</p>
 <p>↑ 43.0 ↑</p> <p>PU43t</p>	 <p>↑ 45.0 ↑</p> <p>P45t</p>	 <p>↑ 26.0 ↑</p> <p>PX26d</p>	 <p>↑ 19.0 ↑</p> <p>PGJ19-1 (2) (3)</p>	 <p>↑ 26.4 ↑</p> <p>P26,4t</p>	 <p>↑ 23.0 ↑</p> <p>PGJ23-1</p>
 <p>↑ 38.8 ↑</p> <p>P29t</p>	 <p>↑ 38.8 ↑</p> <p>PX29t</p>	 <p>↑ 20.0 ↑ ↑ 30.0 ↑ ↑ 36.0 ↑</p> <p>P20d</p>	 <p>↑ 20.0 ↑ ↑ 30.0 ↑ ↑ 36.0 ↑</p> <p>P22d</p>	 <p>↑ 26.35 max. ↑ ↑ 26.45 ↑</p> <p>PG13</p>	 <p>↑ 26.35 max. ↑ ↑ 22.4 ↑</p> <p>PGJ13</p>
 <p>↑ 9.0 ↑</p> <p>BA9s</p>	 <p>↑ 9.0 ↑</p> <p>BAX9s</p>	 <p>↑ 9.0 ↑</p> <p>BAY9s</p>	 <p>↑ 10.0 ↑</p> <p>E10</p>	 <p>↑ 20.0 ↑</p> <p>BA20s</p>	 <p>↑ 21.0 ↑</p> <p>BA21s</p>



 20.0  BA20d	 21.0  BA21d	 15.0  BA15s	 15.0  BA15d	 15.0  BAU15s	 15.0  BAY15d
 15.0  BAZ15d	 10.0  B10d	 8.3  BAX8,3d	 8.4  BAX8,4d	 8.5  BAX8,5d	 8.7  BAX8,7d
 8.0  EBS R4 (6) (10) (11) (12)	 12.5 7.5  14.5 EBS N10	 6.0  SV6	 7.5  SV7-8	 8.5  SV8-8,5	 9.2 2.1  W2,1x9,5d
 16.0  W2,5x16d	 16.0  W2,5x16q	 4.6  W2x4,6d	 16.0 5.0  13.0 W3x16d	 16.0 5.0  13.0 W3x16q	 16.0 5.0  13.0 WX3x16d



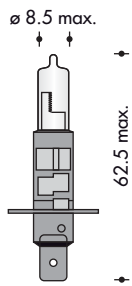

Art.nr.	Type	Description	Volt	Watt	Base
H1 SINGLE FILAMENT HALOGEN P14,5s					8,5 x 62,5 mm
Spot/Fog/Headlamp					
6V					
1010010	H1/6V		6	55	P14,5s
12V					
1010020	H1/12		12	55	P14,5s
1010025	H1/12	HEAVY DUTY	12	55	P14,5s
1010030	H1/12	LONG LIFE	12	55	P14,5s
1010040	H1/12	ALL WEATHER BLUE	12	55	P14,5s
1010050	H1/12	SUPER GOLD	12	55	P14,5s
1010060	H1/12	XENON BLUE	12	55	P14,5s
1010065	H1/12	SUPREME PLUS 30%	12	55	P14,5s
1010066	H1/12	SUPREME PLUS 50%	12	55	P14,5s
1010067	H1/12	SUPREME PLUS 100%	12	55	P14,5s
1010070	H1/12	SUPER WHITE	12	55	P14,5s
1010080	H1/12	OFF ROAD USE/RALLY	12	100	P14,5s
1010090	H1/12	ALL WEATHER BLUE	12	100	P14,5s
1010100	H1/12	SUPER GOLD	12	100	P14,5s
1010110	H1/12	XENON BLUE	12	100	P14,5s
1010120	H1/12	SUPER WHITE	12	100	P14,5s
1010130	H1/12	OFF ROAD USE/RALLY	12	130	P14,5s
1010140	H1/12	ALL WEATHER BLUE	12	130	P14,5s
1010150	H1/12	XENON BLUE	12	130	P14,5s
1010160	H1/12	OFF ROAD USE/RALLY	12	160	P14,5s
24V					
1010170	H1/24		24	70	P14,5s
1010171	H1/24	LONG LIFE	24	70	P14,5s
1010180	H1/24	ALL WEATHER BLUE	24	70	P14,5s
1010190	H1/24	SUPER GOLD	24	70	P14,5s
1010200	H1/24	XENON BLUE	24	70	P14,5s
1010210	H1/24	SUPER WHITE	24	70	P14,5s
1010220	H1/24	OFF ROAD USE/RALLY	24	100	P14,5s
1010230	H1/24	SUPER GOLD	24	100	P14,5s
1010240	H1/24	ALL WEATHER BLUE	24	100	P14,5s
1010250	H1/24	XENON BLUE	24	100	P14,5s
1010260	H1/24	SUPER WHITE	24	100	P14,5s
1010270	H1/24	OFF ROAD USE/RALLY	24	130	P14,5s



P14.5s

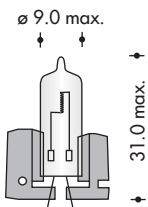

Art.nr.	Type	Description	Volt	Watt	Base
H2 SINGLE FILAMENT HALOGEN X511					9,0 x 31,0 mm
Spot/Fog/Headlamp					
6V					
1020010	H2/6		6	55	X511
12V					
1020020	H2/12		12	55	X511
1020030	H2/12	OFF ROAD USE/RALLY	12	100	X511
1020040	H2/12	OFF ROAD USE/RALLY	12	130	X511
24V					
1020050	H2/24		24	70	X511
1020060	H2/24	OFF ROAD USE/RALLY	24	100	X511
1020070	H2/24	OFF ROAD USE/RALLY	24	130	X511



X511

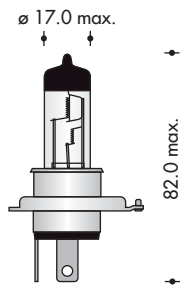

Art.nr.	Type	Description	Volt	Watt	Base
H4 DOUBLE FILAMENT HALOGEN LAMP P43t					17,0 x 82,0 mm
Twin filaments					
6V					
1040010	H4/6		6	25-25	P43t
1040020	H4/6		6	30-30	P43t
1040030	H4/6		6	35-35	P43t
1040040	H4/6		6	45-45	P43t
1040050	H4/6		6	60-55	P43t
1040060	H4/6	YELLOW	6	60-55	P43t
12V					
1040070	HS1	PX43t	12	35-35	PX43t
1040080	H4/12		12	45-45	P43t
1040090	H4/12		12	60-55	P43t
1040100	H4/12	YELLOW	12	60-55	P43t
1040110	H4/12	LONG LIFE	12	60-55	P43t
1040120	H4/12	ALL WEATHER BLUE	12	60-55	P43t
1040130	H4/12	SUPER GOLD	12	60-55	P43t
1040140	H4/12	XENON BLUE	12	60-55	P43t
1040145	H4/12	SUPREME PLUS 30%	12	60-55	P43t
1040146	H4/12	SUPREME PLUS 50%	12	60-55	P43t
1040147	H4/12	SUPREME PLUS 100%	12	60-55	P43t
1040150	H4/12	OFF ROAD USE/RALLY	12	100-55	P43t
1040160	H4/12	ALL WEATHER BLUE	12	100-55	P43t
1040170	H4/12	XENON BLUE	12	100-55	P43t
1040180	H4/12	OFF ROAD USE/RALLY	12	100-80	P43t
1040190	H4/12	ALL WEATHER BLUE	12	100-80	P43t
1040200	H4/12	SUPER GOLD	12	100-80	P43t
1040210	H4/12	OFF ROAD USE/RALLY	12	100-90	P43t
1040220	H4/12	ALL WEATHER BLUE	12	100-90	P43t
1040230	H4/12	XENON BLUE	12	100-90	P43t
1040240	H4/12	OFF ROAD USE/RALLY	12	130-90	P43t
1040250	H4/12	ALL WEATHER BLUE	12	130-90	P43t
1040260	H4/12	XENON BLUE	12	130-90	P43t
1040270	H4/12	OFF ROAD USE/RALLY	12	160-100	P43t
24V					
1040280	H4/24		24	75-70	P43t
1040290	H4/24	HEAVY DUTY	24	75-70	P43t
1040300	H4/24	ALL WEATHER BLUE	24	75-70	P43t
1040310	H4/24	SUPER GOLD	24	75-70	P43t
1040320	H4/24	XENON BLUE	24	75-70	P43t
1040330	H4/24	OFF ROAD USE/RALLY	24	100-80	P43t
1040340	H4/24	OFF ROAD USE/RALLY	24	100-90	P43t
1040350	H4/24	SUPER GOLD	24	100-90	P43t
1040360	H4/24	ALL WEATHER BLUE	24	100-90	P43t
1040370	H4/24	XENON BLUE	24	100-90	P43t
1040380	H4/24	OFF ROAD USE/RALLY	24	100-90	P43t
1040390	H4/24	OFF ROAD USE/RALLY	24	100-90	P43t



P43t

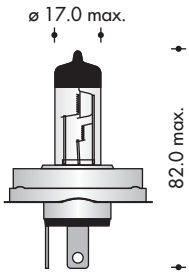

Art.nr.	Type	Description	Volt	Watt	Base
H4 DOUBLE FILAMENT HALOGEN LAMP P45t					17,0 x 82,0 mm
Twin filaments					
6V					
1050010	H4/6	OFF ROAD USE/RALLY	6	60-55	P45t
12V					
1050020	H4/12		12	60-55	P45t
1050060	H4/12	HEAVY DUTY	12	60-55	P45t
1050070	H4/12	OFF ROAD USE/RALLY	12	100-55	P45t
1050100	H4/12	OFF ROAD USE/RALLY	12	100-80	P45t
1050110	H4/12		12	100-90	P45t
1050140	H4/12	OFF ROAD USE/RALLY	12	130-90	P45t
24V					
1050170	H4/24	OFF ROAD USE/RALLY	24	75-70	P45t
1050180	H4/24	OFF ROAD USE/RALLY	24	100-80	P45t
1050200	H4/24	OFF ROAD USE/RALLY	24	100-90	P45t
1050230	H4/24	OFF ROAD USE/RALLY	24	130-90	P45t



P45t

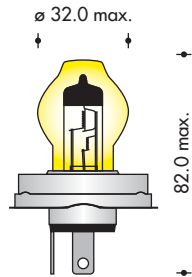

H4 DOUBLE FILAMENT HALOGEN LAMP P43t YELLOW					32,0 x 82,0 mm
6V					
1060010	H4/6	YELLOW	6	60-55	P43t
12V					
1060015	H4/12	YELLOW	12	45-40	P43t
1060020	H4/12	YELLOW	12	60-55	P43t
1060060	H4/12	YELLOW OFF ROAD USE/RALLY	12	60-55	P43t
1060025	H4/12	YELLOW PLUS 100%	12	60-55	P43t
1060030	H4/12	YELLOW OFF ROAD USE/RALLY	12	100-80	P43t
24V					
1060040	H4/24	YELLOW	24	75-70	P43t
1060080	H4/24	YELLOW OFF ROAD USE/RALLY	24	75-70	P43t
1060070	H4/24	YELLOW OFF ROAD USE/RALLY	24	100-80	P43t
1060050	H4/24	YELLOW OFF ROAD USE/RALLY	24	100-90	P43t



P43t

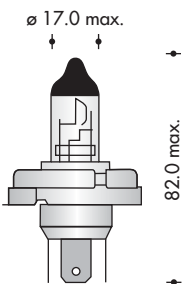

H5 HALOGEN LAMP P45t					17,0 x 82,0 mm
12V					
1050020	12V	OFF ROAD USE/RALLY	12	45-40	P45t
1050025	12V		12	60-55	P45t
1050030	12V		12	75-70	P45t
1050035	12V	OFF ROAD USE/RALLY	12	100-55	P45t
1050040	12V	OFF ROAD USE/RALLY	12	100-90	P45t



P45t

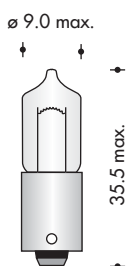

H6 HALOGEN LAMP BAX9s					9,0 x 35,5 mm
12V					
3700010	H6W		12	6	BAX9s
3700015	H6W	LONG LIFE	12	6	BAX9s



BAX9s

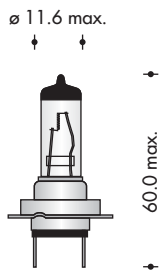

Art.nr.	Type	Description	Volt	Watt	Base
HALOGEN LAMP H7 PX26d					11,6 x 60,0 mm
12V					
1070010	H7/12		12	55	PX26d
1070015	H7/12	LONG LIFE	12	55	PX26d
1070020	H7/12	SUPER WHITE	12	55	PX26d
1070030	H7/12	ALL WEATHER BLUE	12	55	PX26d
1070040	H7/12	XENON BLUE	12	55	PX26d
1070046	H7/12	SUPREME PLUS 30%	12	55	PX26d
1070047	H7/12	SUPREME PLUS 50%	12	55	PX26d
1070048	H7/12	SUPREME PLUS 100%	12	55	PX26d
1070050	H7/12		12	100	PX26d
1070060	H7/12	XENON BLUE	12	100	PX26d
1070070	H7/12	ALL WEATHER BLUE	12	100	PX26d



PX26d

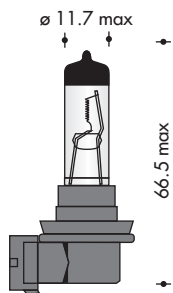

Art.nr.	Type	Description	Volt	Watt	Base
HALOGEN LAMP H7 PX26d					11,6 x 60,0 mm
24V					
1070080	H7/24		24	70	PX26d
1070090	H7/24	SUPER WHITE	24	70	PX26d
1070100	H7/24	ALL WEATHER BLUE	24	70	PX26d
1070110	H7/24	XENON BLUE	24	70	PX26d
1070115	H7/24	LONG LIFE	24	70	PX26d
1070085	H7/24		24	100	PX26d

H8 HALOGEN LAMP PGJ19-1 **11,7 x 66,5 mm**

Art.nr.	Type	Description	Volt	Watt	Base
12V					
1080010	H8/12		12	35	PGJ19-1
1080015	H8/12	SUPREME PLUS 30%	12	35	PGJ19-1



PGJ19-1

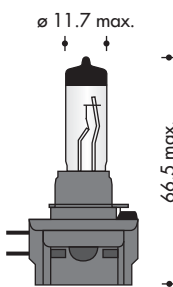

H8B HALOGEN LAMP PGJ19-1 **11,7 x 66,5 mm**

Art.nr.	Type	Description	Volt	Watt	Base
12V					
1080055	H8B		12	35	PGJY19-1



PGJY19-1

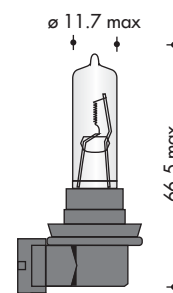

H9 HALOGEN LAMP PGJ19-5 **11,7 x 66,5 mm**

Art.nr.	Type	Description	Volt	Watt	Base
12V					
1090010	H9/12		12	65	PGJ19-5
1090015	H9/12	SUPREME PLUS 30%	12	65	PGJ19-5



PGJ19-5

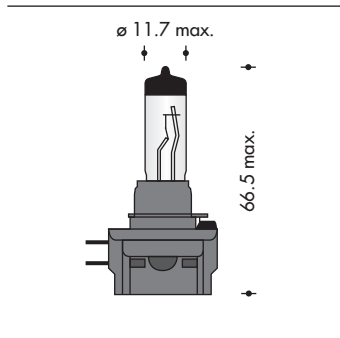

Art.nr.	Type	Description	Volt	Watt	Base
					H9B HALOGEN LAMP PGJY19-5
					11,7 x 66,5 mm

12V					
1090055	H9B		12	65	PGJY19-5



PGJY 19-5

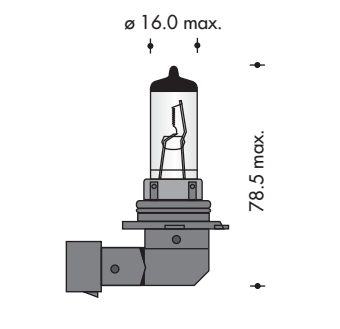

					H10 HALOGEN LAMP PY20d
					16,0 x 78,5 mm

12V					
1100010	H10/12		12	45	PY20d



PY20d

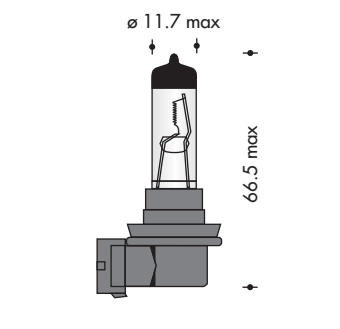

					H11 HALOGEN LAMP PGJ19-2
					11,7 x 66,5 mm

12V					
1110010	H11/12		12	55	PGJ19-2
1110015	H11/12	SUPREME PLUS 30%	12	55	PGJ19-2

24V					
1110011	H11/24		24	70	PGJ19-2



PGJ 19-2

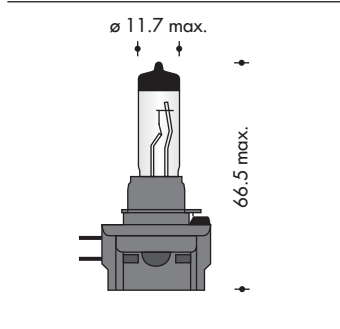

					H11B HALOGEN LAMP PGJY19-2
					11,7 x 66,5 mm

13,2V					
1110050	H11B		13,2	55	PGJY19-2



PGJ 19-2

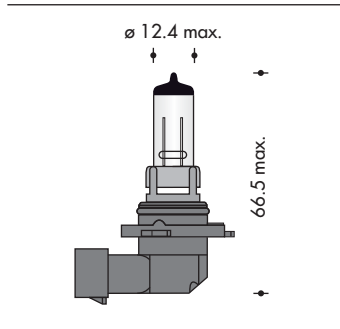

					H12 HALOGEN LAMP PZ20d
					12,4 x 66,5 mm

12V					
1120010	H12/12		12	53W	PZ20d

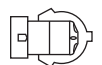

PZ20d

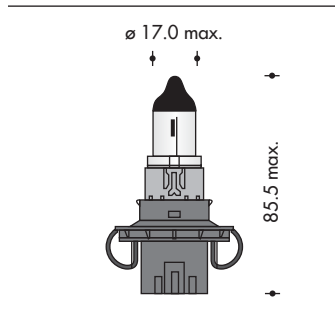

Art.nr.	Type	Description	Volt	Watt	Base
H13 HALOGEN LAMP P26,4t					17,0 x 85,5 mm

12V					
1130010	H13/12		12	60-55	P26,4t



P26,4t

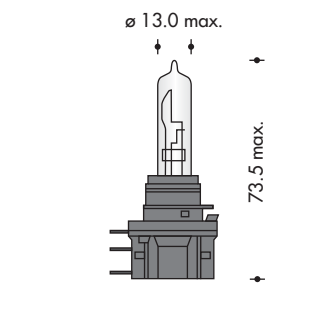

H15 HALOGEN LAMP PGJ23t-1					13,0 x 73,5 mm
----------------------------------	--	--	--	--	-----------------------

12V					
1140010	H15/12		12	15-55	PGJ23t-1



PGJ23t-1

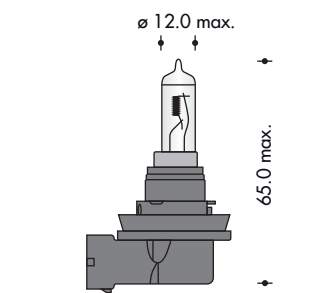

H16 HALOGEN LAMP PGJ19-3					12,0 x 65,0 mm
---------------------------------	--	--	--	--	-----------------------

12V					
1150010	H16/12		12	19	PGJ19-3



PGJ19-3

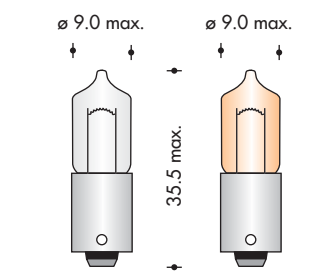

H21 HALOGEN LAMP BAY9s					9,0 x 35,5 mm
-------------------------------	--	--	--	--	----------------------

12V					
3700020	H21W		12	21	BAY9s
3700025	H21W	LONG LIFE	12	21	BAY9s
3700026	H21W	AMBER	12	21	BAY9s



BAY9s

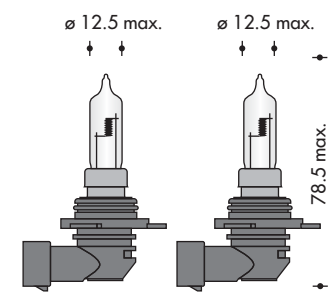

HALOGEN INFRARED LAMPTYPES (SPECIAL) PX20d/PX22d					12,5 x 78,5 mm
---	--	--	--	--	-----------------------

12V					
1170010	HIR1 (9011)		12	65	PX20d
1170020	HIR2 (9012)		12	55	PX22d



PX20d



PX22d

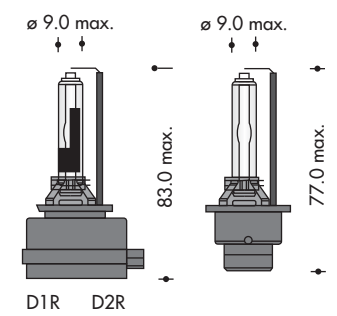
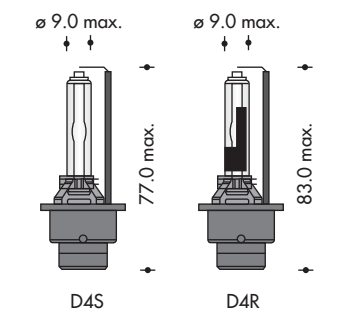
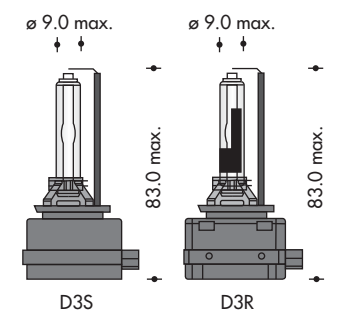
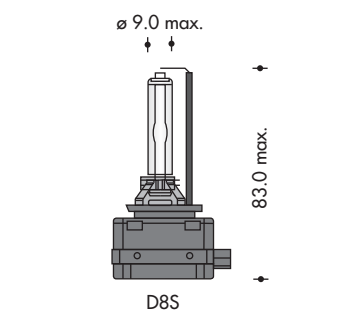
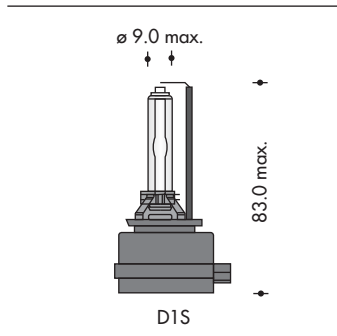

Art.nr.	Type	Description	Volt	Watt	Base
XENON HEADLIGHT (HID) P32d-/PK32d- (H.I.D. LAMPS)					
High Intensity Discharge lamps					
<hr/>					
<hr/>					
<hr/>					
12V 9,0 x 83,0 mm					
1180010	D1S		12	35	PK32d-2
<hr/>					
<hr/>					
<hr/>					
40V 9,0 x 83,0 mm					
1180020	D8S		40	25	PK32d-1
<hr/>					
<hr/>					
<hr/>					
42V 9,0 x 83,0 mm					
1180030	D3S		42	35	PK32d-5
1180040	D3R		42	35	PK32d-6
<hr/>					
<hr/>					
<hr/>					
9,0 x 77,0 mm					
1180050	D4S		42	35	P32d-5
<hr/>					
<hr/>					
9,0 x 83,0 mm					
1180060	D4R		42	35	PK32d-1
<hr/>					
<hr/>					
<hr/>					
85V 9,0 x 83,0 mm					
1180070	D1R		85	35	PK32d-3
<hr/>					
<hr/>					
9,0 x 77,0 mm					
1180080	D2S		85	35	P32d-2
<hr/>					
<hr/>					
9,0 x 83,0 mm					
1180090	D2R		85	35	P32d-3
<hr/>					
<hr/>					



Art.nr.	Type	Description	Volt	Watt	Base
---------	------	-------------	------	------	------

GB The main benefits of HID headlights

Improved Visibility: HID headlights produce a brighter, more natural light than halogen headlights. The light produced by halogen headlights is slightly yellow, which can be distracting. Studies have learned that drivers using HID headlights (more white), have more visibility, which can increase the reaction time in an emergency situation.

Longer Lasting: HID headlights last up to three times as long as halogen bulbs. This means less maintenance for vehicle owners and less waste produced.

Lower Energy Usage: HID headlights consume much less energy than halogen bulbs, around 25 to 30 percent less. Since the energy used for headlights is provided by your car's electrical system and battery, HID headlights can possibly extend the life of your car's charging system.

More Attractive: Many drivers upgrade to HID headlights as a fashion statement. The look is much cleaner and more sophisticated than yellowed halogen bulbs. Because HID headlights are often associated with luxury cars, installing them in your vehicle can be an aesthetic upgrade.

FR Principaux avantages des phares DHI

Meilleure visibilité: Les phares DHI produisent une lumière plus éclatante et plus naturelle que celle des phares halogènes. La lumière produite par les phares halogènes est légèrement jaune, ce qui peut être source de distraction. Des études ont montré que les conducteurs qui utilisent des phares DHI (plus blancs) bénéficient d'une meilleure visibilité, ce qui peut améliorer le temps de réaction en situation d'urgence.

Longévité accrue: Les phares DHI durent jusqu'à trois fois plus longtemps que les lampes halogènes. Cela signifie moins d'entretien pour les propriétaires de véhicule et une diminution des déchets produits.

Consommation d'énergie plus faible: Les phares DHI consomment beaucoup moins d'énergie que les lampes halogènes (environ 25 à 30 pour cent de moins). Comme l'énergie utilisée pour les phares est fournie par la batterie et le système électrique de votre voiture, l'utilisation de phares DHI peut prolonger la durée de vie du système de charge du véhicule.

Plus attrayants: De nombreux conducteurs passent aux phares DHI pour affirmer leur style. L'aspect de ces phares est plus net et plus sophistiqué que celui des lampes halogènes jaunâtres. Comme les phares DHI sont souvent associés à des voitures de luxe, leur installation sur votre véhicule peut constituer une amélioration esthétique.

D Die Hauptvorteile von HID-Scheinwerfern

Verbesserte Sichtweite: HID-Scheinwerfer geben ein helleres und natürlicheres Licht ab als Halogenscheinwerfer. Das von Halogenscheinwerfern abgegebene Licht ist leicht gelb, was bisweilen als störend empfunden wird. Studien haben gezeigt, dass Fahrer mit HID-Scheinwerfern (weißer) von einer besseren Sicht profitieren, was auch zu einer erhöhten Reaktionszeit in Unfallsituationen führen kann.

Längere Lebenszeit: HID-Scheinwerfer halten bis zu dreimal länger als Halogenlampen. Dadurch verringert sich der Wartungsaufwand für Fahrzeugbesitzer und es entsteht weniger Abfall.

Geringer Energieverbrauch: HID-Scheinwerfer verbrauchen 25-30 % weniger Energie als Halogenlampen. Da die Energie für Ihre Scheinwerfer von dem elektrischen System und der Batterie Ihres Fahrzeugs bereitgestellt wird, können HID-Scheinwerfer sogar die Lebensdauer des Ladesystems Ihres Fahrzeugs verlängern.

Attraktiver: Viele Fahrer rüsten Ihr Fahrzeug mit HID-Scheinwerfern nach - als Modestatement. Der Look ist simpler und eleganter als bei den eher gelblichen Halogenlampen. Weil HID-Scheinwerfer häufig mit Luxusfahrzeugen assoziiert werden, ist der Einbau in Ihr Fahrzeug auch ein ästhetisches Plus.

E Principales ventajas de los faros HID

Visibilidad mejorada: Los faros HID producen una luz más brillante y natural que la de los halógenos. La luz de los faros halógenos tiene un color ligeramente amarillo, lo que puede causar distracciones. Los estudios han demostrado que los conductores que usan faros HID (con luz más blanca) gozan de más visibilidad, lo que puede incrementar el tiempo de reacción en situaciones de emergencia.

Mayor duración: Los faros HID duran hasta tres veces más que las bombillas halógenas. Esto significa menos tareas de mantenimiento para el dueño del vehículo y menos generación de residuos.

Bajo consumo: Los faros HID consumen mucha menos energía que las bombillas halógenas. Alrededor de un 25% o 30% menos. Debido a que los faros obtienen la energía del sistema eléctrico y de la batería del coche, los faros HID pueden alargar la vida del sistema de carga del coche.

Más atractivos: Muchos conductores se pasan a los faros HID como una declaración de estilo. Tienen un diseño mucho más limpio y sofisticado que el de las bombillas halógenas amarillentas. Los faros HID se suelen asociar a coches de lujo, por lo que instalarlos en su vehículo puede suponer una mejora estética.

I I principali vantaggi dei fari HID

Visibilità migliorata: le lampade HID producono una luce più luminosa, più naturale delle lampade alogene. La luce prodotta dalle lampade alogene è leggermente gialla, e può essere fonte di distrazione. Gli studi hanno dimostrato che i guidatori che utilizzano lampade HID (più bianchi) hanno maggiore visibilità, che può migliorare il tempo di reazione in situazioni di emergenza.

Maggiore durata: Le lampade HID possono durare fino a tre volte più a lungo rispetto le lampadine alogene. Questo significa meno manutenzione per i proprietari di veicoli e meno rifiuti prodotti.

Basso consumo di energia: Le lampade HID consumano molta meno energia rispetto alle lampadine alogene, circa il 25 al 30% in meno. Poiché l'energia utilizzata per i fari è fornita dall'impianto elettrico dell'auto e dalla batteria, le lampade HID possono prolungare la vita di quest'ultima.

Più attraente: Molti guidatori vorrebbero aggiornare con le lampade HID le proprie auto. Il look è molto più pulito e sofisticato rispetto alle lampadine alogene. Le lampade HID sono spesso associate alle auto di lusso, installarle nel vostro veicolo può essere un aggiornamento estetico.

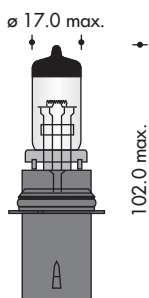

AMERICAN HALOGEN HEAD LAMP P29t

17,0 x 102,0 mm

Double filament

12V

Part No.	Code	Application	Volt	Power	Base
9700010	HB1 (9004)		12	65-45	P29t
9700020	HB1 (9004)	OFF ROAD USE/RALLY	12	100-55	P29t
9700030	HB1 (9004)	OFF ROAD USE/RALLY	12	100-55	P29t
9700040	HB1 (9004)	LONG LIFE	12	65-45	P29t



P29t

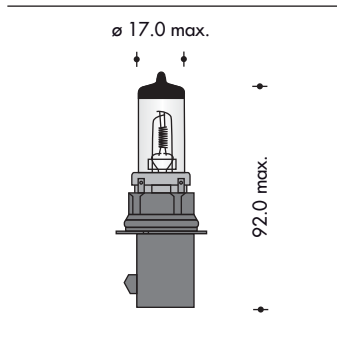

Art.nr.	Type	Description	Volt	Watt	Base
AMERICAN HALOGEN HEAD LAMP P43t					17,0 x 92,0 mm
Double filament					

12V					
9700045	HB2/H4 (9003)		12	60-55	P43t



P43t

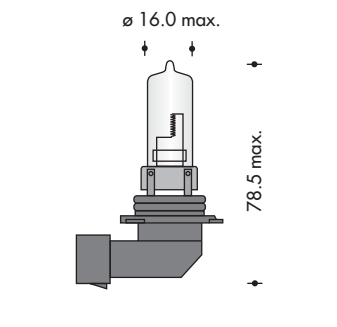

AMERICAN HALOGEN HEAD LAMP P20d					12,4 x 78,5 mm
Single filament					

12V					
9800010	HB3 (9005)		12	60	P20d
9800012	HB3 (9005)	SUPER WHITE	12	60	P20d
9800015	HB3 (9005)	RALLY	12	80	P20d
9800020	HB3 (9005)	OFF ROAD USE/RALLY	12	100	P20d



P20d

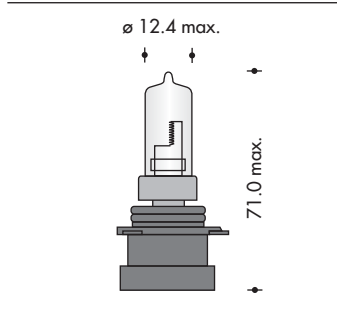

AMERICAN HALOGEN HEAD LAMP P20d					12,4 x 71,0 mm
Single filament					

12V					
9800025	HB3A (9005XS)		12	60	P20d



P20d

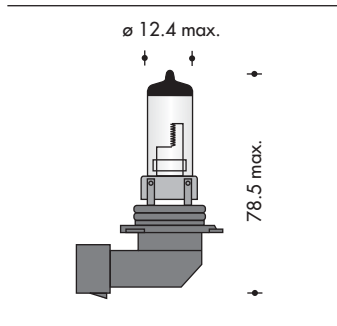

AMERICAN HALOGEN HEAD LAMP BULB P22d					12,4 x 78,5 mm
Single filament					

12V					
9800030	HB4 (9006)		12	51	P22d
9800035	HB4 (9006)	RALLY	12	80	P22d
9800040	HB4 (9006)	OFF ROAD USE/RALLY	12	100	P22d



P22d

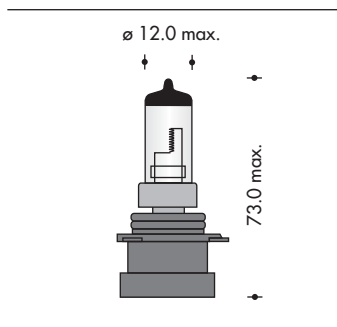

AMERICAN HALOGEN HEAD LAMP BULB P22d					12,0 x 73,0 mm
Single filament					

12V					
9800055	HB4A (9006XS)		12	51	P22d
9800060	HB4A (9006XS)		12	80	P22d



P22d

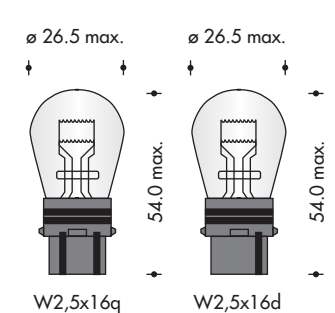
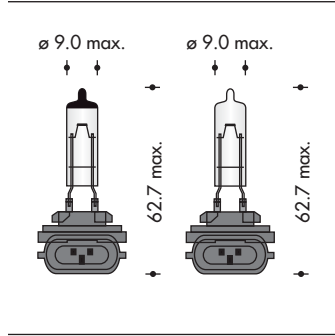
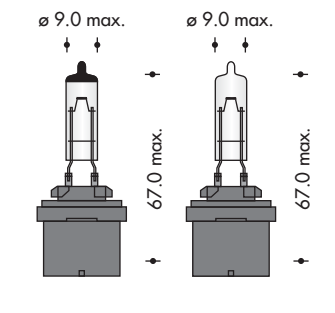
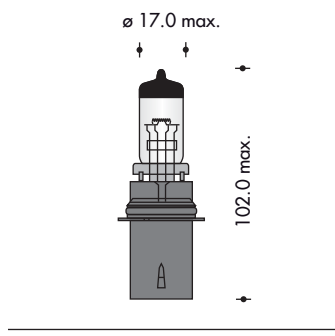
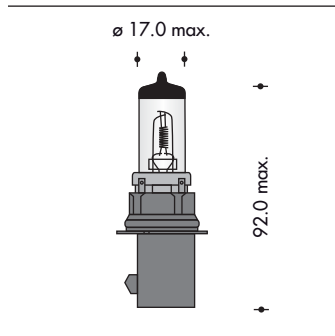

Art.nr.	Type	Description	Volt	Watt	Base
AMERICAN HALOGEN HEAD LAMP PX29t					17,0 x 60,0 mm
Double filament					
12V					
9700045	HB5 (9007)		12	65-55	PX29t
AMERICAN HALOGEN HEAD LAMP PX29t					
Double filament					
12V					
9700040	HB7		12	65-55	PX29t
AMERICAN HALOGEN HEAD LAMP PG13					9,0 x 67,0 mm
Single filament					
12,8V					
9600010	H27W/1	BLACK TOP 880	12,8	27	PG13
9600020		CLEAR TOP 890	12,8	27	PG13
9600030		BLACK TOP 893	12,8	37,5	PG13
9600040		CLEAR TOP 885	12,8	50	PG13
AMERICAN HALOGEN HEAD LAMP PGJ13					9,0 x 62,7 mm
Single filament					
12,8V					
9600050	H27W/2	BLACK TOP 881	12,8	27	PGJ13
9600060		CLEAR TOP 889	12,8	27	PGJ13
9600070		CLEAR TOP 894	12,8	37,5	PGJ13
9600080		CLEAR TOP 886	12,8	50	PGJ13
AMERICAN INCANDESCENT LAMP TYPES S25 W2,5x16q					26,5 x 54,0 mm
(Chrysler / Pontiac / Oldsmobile etc.)					
12V					
9900010	3057	S25q	12	32/2CP	W2,5x16q
9900020	3057A	S25q AMBER	12	32/2CP	W2,5x16q
9900030	3156	S25d	12	32CP	W2,5x16d
9900040	3156A	S25d AMBER	12	32CP	W2,5x16d
9900050	3157	S25q	12	32/3CP	W2,5x16q
9900060	3157A	S25q AMBER	12	32/3CP	W2,5x16q
9900070	3357/3457	S25q	12	40/3CP	W2,5x16q
9900080	3357A/3457A	S25q AMBER	12	40/3CP	W2,5x16q
9900090	3357A	S25q	12-14	32/2CP	W2,5x16q



PX29t



PX29t



PG13



PGJ13



W2,5x16d



W2,5x16q



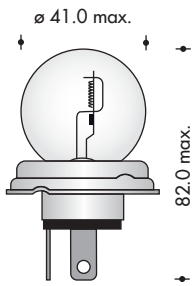

Art.nr.	Type	Description	Volt	Watt	Base
ASYMMETRICAL HEADLIGHT LAMP P45t					41,0 x 82,0 mm
Double filament					
6V					
1300910	R2		6	45-40	P45t
1301010	R2 Y	YELLOW	6	45-40	P45t
12V					
1301910	R2		12	45-40	P45t
1302010	R2 Y	YELLOW	12	45-40	P45t
1305810	R2	OFF ROAD USE/RALLY	12	75-75	P45t
1302410	R2 Y	YELLOW	12	75-75	P45t
24V					
1303710	R2		24	55-50	P45t
1304010	R2 Y	YELLOW	24	55-50	P45t
1306110	R2	OFF ROAD USE/RALLY	24	75-75	P45t



P45t

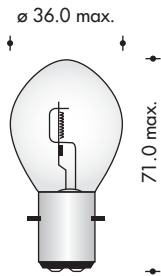

Art.nr.	Type	Description	Volt	Watt	Base
SYMMETRICAL HEADLIGHT LAMP BA20d					36,0 x 71,0 mm
Double filament					
6V					
1300505			6	15-15	BA20d
1300605			6	18-18	BA20d
1300705			6	20-20	BA20d
1300310	S1		6	25-25	BA20d
1300510	S2		6	35-35	BA20d
1300710			6	45-40	BA20d
12V					
1301110			12	15-15	BA20d
1301310	S1		12	25-25	BA20d
1301210			12	20-20	BA20d
1301510	S2		12	35-35	BA20d
1301710			12	45-40	BA20d
24V					
1303210			24	35-35	BA20d
1303310			24	45-40	BA20d
1303410	Y	YELLOW	24	45-40	BA20d
1303910			24	55-50	BA20d



BA20d

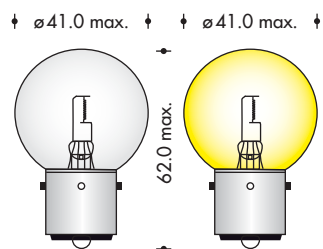

Art.nr.	Type	Description	Volt	Watt	Base
FRENCH SOCKET 3 PIN SYMMETRIC LAMP BA21s					41,0 x 62,0 mm
6V					
1500030			6	35	BA21s
1500040			6	45	BA21s
1500050			6	50	BA21s
12V					
1500060			12	35	BA21s
1500070	Y	YELLOW	12	35	BA21s
1500080			12	45	BA21s
1500090	Y	YELLOW	12	45	BA21s
1500010			12	50	BA21s
24V					
1500100			24	35	BA21s
1500110			24	45	BA21s
1500020			24	50	BA21s



BA21s

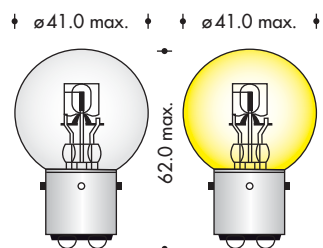

FRENCH SOCKET 3 PIN SYMMETRIC LAMP BA21d					41,0 x 62,0 mm
Double filament					
6V					
1501010			6	35-35	BA21d
1501020			6	45-40	BA21d
1501030	Y	YELLOW	6	45-40	BA21d
12V					
1501035			12	35-35	BA21d
1501040			12	45-40	BA21d
1501050	Y	YELLOW	12	45-40	BA21d
24V					
1501060			24	45-40	BA21d
1501070	Y	YELLOW	24	45-40	BA21d



BA21d

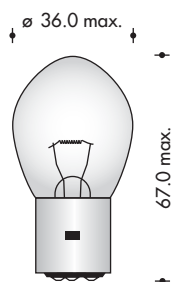

SINGLE AXIAL FILAMENT HEADLIGHT LAMP BA20d					36,0 x 67,0 mm
6V					
1200510			6	25	BA20d
1201310			6	35	BA20d
12V					
1202310			12	25	BA20d
1204010			12	35	BA20d
1205210			12	45	BA20d
1206210			12	50	BA20d
24V					
1207110			24	25	BA20d
1207810			24	35	BA20d
1209110			24	45	BA20d
1209910			24	50	BA20d



BA20d

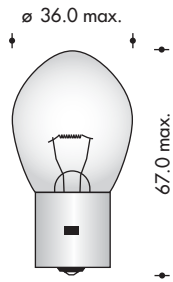

Art.nr.	Type	Description	Volt	Watt	Base
SINGLE AXIAL FILAMENT HEADLIGHT LAMP BA20s					36,0 x 67,0 mm
6V					
1200110			6	20	BA20s
1200810			6	25	BA20s
1201610			6	35	BA20s
1202110			6	45	BA20s
1202210			6	50	BA20s
12V					
1202510			12	25	BA20s
1204310	F2		12	35	BA20s
1205410			12	45	BA20s
1206110			12	50	BA20s
24V					
1207310			24	25	BA20s
1208010			24	35	BA20s
1209310			24	45	BA20s
1210110			24	50	BA20s



BA20s

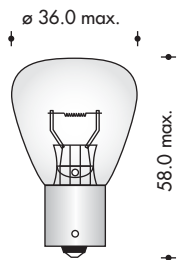

Art.nr.	Type	Description	Volt	Watt	Base
AXIAL FILAMENT HEADLIGHT LAMP BA15s					36,0 x 58,0 mm
6V					
1201710			6	35	BA15s
1210910			6	45	BA15s
12V					
1203910			12	35	BA15s
1205010			12	36	BA15s
1205610			12	45	BA15s
1205910			12	50	BA15s
24V					
1208310			24	35	BA15s
1208810			24	36	BA15s
1209710			24	45	BA15s



BA15s

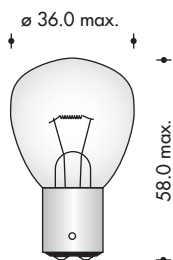

Art.nr.	Type	Description	Volt	Watt	Base
AXIAL FILAMENT HEADLIGHT LAMP BA15d					36,0 x 58,0 mm
6V					
1201210			6	35	BA15d
1201410			6	45	BA15d
12V					
1204610			12	35	BA15d
1204910			12	36	BA15d
1205510			12	45	BA15d
1206410			12	50	BA15d
24V					
1208110			24	35	BA15d
1208910			24	36	BA15d
1509510			24	45	BA15d



BA15d



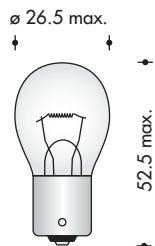
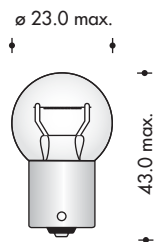

Art.nr.	Type	Description	Volt	Watt	Base
SINGLE FILAMENT LAMP BA15s					23,0 x 43,0 mm
Rear / Flasher lamp					
6V					
1700010			6	15	BA15s
12V					
1700020			12	15	BA15s
24V					
1700030			24	15	BA15s
SINGLE FILAMENT LAMP BA15s (S25)					26,5 x 52,5 mm
Flasher / Stop / Direction / Reverse and Foglight					
6V					
1103210	R10W		6	10	BA15s
1101310			6	15	BA15s
1102010			6	18	BA15s
1110910			6	20	BA15s
1102410	P21W		6	21	BA15s
1100710			6	25	BA15s
12V					
1103010	R10W		12	10	BA15s
1103910			12	15	BA15s
1105610			12	18	BA15s
1105910			12	20	BA15s
1106010	P21W		12	21	BA15s
1106015	P21W HD	HEAVY DUTY	24	21	BA15s
1106510	PY21W	AMBER	12	21	BA15s
1106910	P21W	RED	12	21	BA15s
1102310			12	25	BA15s
24V					
1103310	R10W		24	10	BA15s
1107910			24	15	BA15s
1108910			24	18	BA15s
1109310			24	20	BA15s
1109710	P21W		24	21	BA15s
1101610	P21W HD	HEAVY DUTY	24	21	BA15s
1111310			24	24	BA15s
1100810			24	25	BA15s
28V					
1111410			28	10	BA15s
1110310			28	20	BA15s
1110110			28	21	BA15s
1111010	HD	HEAVY DUTY	28	21	BA15s
1110510			28	26	BA15s
1110810			28	28	BA15s



BA15s



BA15s

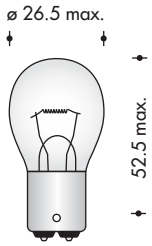

Art.nr.	Type	Description	Volt	Watt	Base
SINGLE FILAMENT LAMP BA15d (S25)					26,5 x 52,5 mm
Flasher / Stop / Direction / Reverse & Foglight					

6V					
1103610	R10W		6	10	BA15d
1101110			6	15	BA15d
1101810			6	18	BA15d
1102110			6	20	BA15d
1102210	P21W		6	21	BA15d
1100910			6	25	BA15d



BA15d

12V					
1103110	R10W		12	10	BA15d
1103710			12	15	BA15d
1105710			12	20	BA15d
1105810	P21W		12	21	BA15d
1102510			12	25	BA15d

24V					
1103410	R10W		24	10	BA15d
1107810			24	15	BA15d
1108610			24	18	BA15d
1109110			24	20	BA15d
1109510	P21W		24	21	BA15d
1101710	P21W HD	HEAVY DUTY	24	21	BA15d
1111210			24	24	BA15d
1101215			24	35	BA15d
1101220			24	45	BA15d

28V					
1111510			28	21	BA15d
1110210	HD	HEAVY DUTY	28	21	BA15d
1110410			28	26	BA15d
1110610	HD	HEAVY DUTY	28	26	BA15d
1110710			28	28	BA15d

SINGLE FILAMENT LAMP BAU15s (S25)					26,5 x 52,5 mm
Direction lamp					

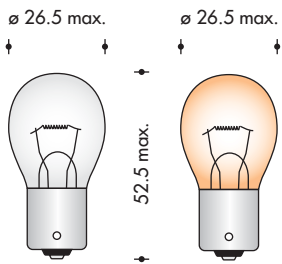

12V					
1102810	PY21W		12	21	BAU15s
1105310	PY21W	AMBER	12	21	BAU15s
1105510	PY21W	AMBER HEAVY DUTY	12	21	BAU15s
1105410	PY21W	RED	12	21	BAU15s



BAU15s

24V					
1109610	PY21W	AMBER	24	21	BAU15s
1109620	PY21W	AMBER HEAVY DUTY	24	21	BAU15s
1109630	PY21W	RED	24	21	BAU15s

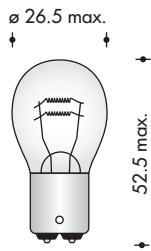

Art.nr.	Type	Description	Volt	Watt	Base
DOUBLE FILAMENT LAMP BA15d (S25)					26,5 x 52,5 mm
Stop / Rear / Flasher lamp					
6V					
1400110			6	18-5	BA15d
1401310			6	21-5	BA15d
12V					
1402210			12	18-5	BA15d
1400910	P21/5W		12	21-5	BA15d
24V					
1401615			24	18-5	BA15d
1401610			24	20-5	BA15d
1401510	P21/5W		24	21-5	BA15d



BA15d

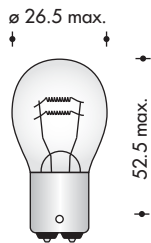

Art.nr.	Type	Description	Volt	Watt	Base
DOUBLE FILAMENT LAMP BAY15d (S25)					26,5 x 52,5 mm
Stop / Rear / Flasher lamp					
6V					
1400210			6	18-5	BAY15d
1400310			6	20-5	BAY15d
1400610	P21/5W		6	21-5	BAY15d
12V					
1402605			12	10-5	BAY15d
1402610			12	10-10	BAY15d
1401010			12	18-5	BAY15d
1400710			12	20-5	BAY15d
1401110	P21/5W		12	21-5	BAY15d
1400810	P21/5W	AMBER	12	21-5	BAY15d
1401410	P21/5W	RED	12	21-5	BAY15d
1402510			12	25-8	BAY15d
24V					
1402310			24	10-10	BAY15d
1400410			24	18-4	BAY15d
1400510			24	18-5	BAY15d
1402010			24	20-5	BAY15d
1401710	P21/5W		24	21-5	BAY15d
1401715	HD	HEAVY DUTY	24	21-5	BAY15d
1401910			24	24-6	BAY15d
1401810			24	25-7	BAY15d
1402410			24	25-10	BAY15d



BAY15d

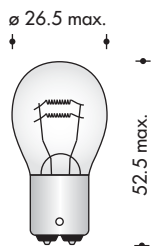

Art.nr.	Type	Description	Volt	Watt	Base
DOUBLE FILAMENT LAMP BAZ15d (S25)					26,5 x 52,5 mm
Stop / End / Tail light / Signalisation					
12V					
1401210	P21/4W		12	21-4	BAZ15d
24V					
1402110	P21/4W		24	21-4	BAZ15d



BAZ15d

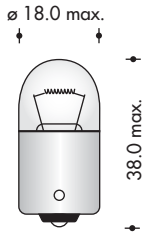

Art.nr.	Type	Description	Volt	Watt	Base
PARKING / TAIL / INDICATOR / WARNING / INTERIOR LAMP BA15s			G - 18,0 x 38,0 mm		
Globular shape G-18					
6V					
0700610			6	3	BA15s
0701010	R5W		6	5	BA15s
0702010	R10W		6	10	BA15s
12V					
0701310			12	3	BA15s
0701810	R5W		12	5	BA15s
0703510	R10W		12	10	BA15s
24V					
0703310	R5W		24	5	BA15s
0705010	R5W HD	HEAVY DUTY	24	5	BA15s
0702710	R10W		24	10	BA15s
28V					
0704210			28	5	BA15s
0704710			28	7	BA15s



BA15s

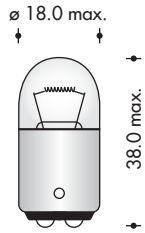

Art.nr.	Type	Description	Volt	Watt	Base
PARKING / TAIL / INDICATOR / WARNING / INTERIOR LAMP BA15d			G - 18,0 x 38,0 mm		
Globular shape G-18					
6V					
0705410			6	3	BA15d
0700710	R5W		6	5	BA15d
0700810	R10W		6	10	BA15d
12V					
0701110			12	3	BA15d
0701710	R5W		12	5	BA15d
0702110	R10W		12	10	BA15d
24V					
0703110	R5W		24	5	BA15d
0705210	R5W HD	HEAVY DUTY	24	5	BA15d
0704910	R10W		24	10	BA15d
0702610	R10W HD	HEAVY DUTY	24	10	BA15d
28V					
0702810			28	5	BA15d
0704610			28	7	BA15d



BA15d



∅ 16.5 max.

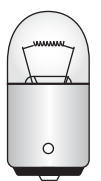

38.0 max.

Art.nr.	Type	Description	Volt	Watt	Base
PARKING / TAIL / INDICATOR / WARNING / INTERIOR LAMP BA15s					T 16,5 x 38,0 mm
Tubular shape T-16					
6V					
0700510			6	3	BA15s
0700910	R5W		6	5	BA15s
0701910	R10W		6	10	BA15s
12V					
0701410			12	3	BA15s
0701510	R5W		12	5	BA15s
0703410	R10W		12	10	BA15s
0703420	Red	RED	12	10	BA15s
24V					
0703210	R5W		24	5	BA15s
0703710	R5W HD	HEAVY DUTY	24	5	BA15s
0704310	R10W		24	10	BA15s
0704810	R10W HD	HEAVY DUTY	24	10	BA15s
28V					
0702510			28	5	BA15s
0705110			28	7	BA15s
0705310	HD	HEAVY DUTY	28	7	BA15s



BA15s

∅ 16.5 max.

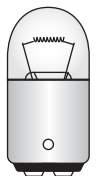

38.0 max.

Art.nr.	Type	Description	Volt	Watt	Base
PARKING / TAIL / INDICATOR / WARNING / INTERIOR LAMP BA15d					T 16,5 x 38,0 mm
Tubular shape T16					
6V					
0700310	R5W		6	5	BA15d
0700410	R10W		6	10	BA15d
12V					
0701210			12	3	BA15d
0701610	R5W		12	5	BA15d
0704010	R10W		12	10	BA15d
24V					
0703010	R5W		24	5	BA15d
0703610	R5W HD	HEAVY DUTY	24	5	BA15d
0704110	R10W		24	10	BA15d
0704410	R10W HD	HEAVY DUTY	24	10	BA15d
28V					
0702210			28	5	BA15d
0702310	HD	HEAVY DUTY	28	5	BA15d
0702410			28	7	BA15d
0704510	HD	HEAVY DUTY	28	7	BA15d
0702910	HD	HEAVY DUTY	28	10	BA15d



BA15d

∅ 28.0 max.

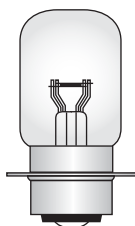

62.0 max.

Art.nr.	Type	Description	Volt	Watt	Base
PREFOCUS SYMMETRIC LAMP P22s					28,0 x 62,0 mm
12V					
1801010			12	35	P22s
1801020			12	45	P22s
24V					
1801030			24	35	P22s
1801040			24	45	P22s



P22s

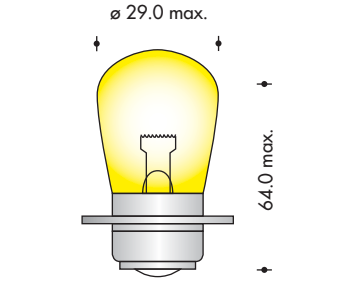
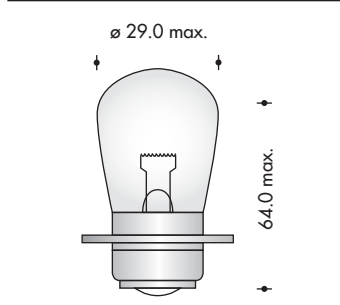
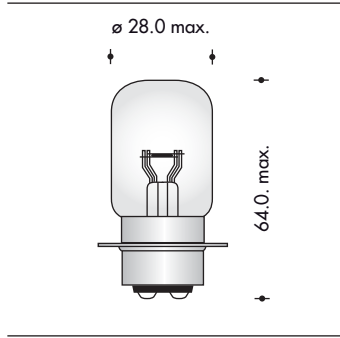

Art.nr.	Type	Description	Volt	Watt	Base
PREFOCUS SYMMETRIC LAMP P22d					28,0 x 64,0 mm
6V					
1802010			6	35-35	P22d
1802020			6	45-40	P22d
12V					
1802030			12	35-35	P22d
1802040			12	45-40	P22d
24V					
1802050			24	45-40	P22d



P22d

SPECIAL AUTO LAMP P36s					29,0 x 64,0 mm
6V					
1201910			6	36	P36s
1201915		YELLOW	6	36	P36s
12V					
1205810			12	48	P36s
24V					
1209010			24	44	P36s



P36s



	Art.nr.	Type	Description	Volt	Watt	Base
<hr/>						
<hr/>						



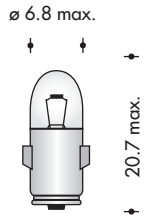

Art.nr.	Type	Description	Volt	Watt	Base
DASHBOARD LAMP BA7s					T - 6,8 x 20,7 mm
6V					
0600410			6	0,6	BA7s
0600810			6	1,2	BA7s
0600910			6	1,5	BA7s
0601010			6	2	BA7s
12V					
0602310			12	1,2	BA7s
0602810			12	2	BA7s
24V					
0605310	T2W		24	2	BA7s
0606710			24	3	BA7s



BA7s

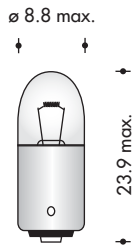

Art.nr.	Type	Description	Volt	Watt	Base
DASHBOARD LAMP BA9s					T - 8,8 x 23,9 mm
6V					
0601310			6	2	BA9s
0601410			6	3	BA9s
12V					
0603010	T2W		12	2	BA9s
0603710	T3W		12	3	BA9s
0603910	T4W		12	4	BA9s
24V					
0605510	T2W		24	2	BA9s
0606910			24	3	BA9s
0606915	T4W		24	4	BA9s
28V					
0608310			28	2	BA9s



BA9s

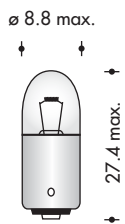

Art.nr.	Type	Description	Volt	Watt	Base
DASHBOARD LAMP / PARKING LAMP BA9s					T - 8,8 x 27,4 mm
6V					
0601610			6	3	BA9s
0601910	T4W		6	4	BA9s
0601810			6	5	BA9s
12V					
0603810	T3W		12	3	BA9s
0604110	T4W		12	4	BA9s
0604310	T5W		12	5	BA9s
24V					
0607110	T3W		24	3	BA9s
0607410	T4W		24	4	BA9s



BA9s

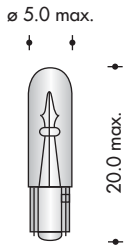

Art.nr.	Type	Description	Volt	Watt	Base
WEDGE BASE W2 x 4,6d T5					T - 5,0 x 20,0 mm
Inside Illumination / Dashboard lamp					
6V					
2200010			6	1	W2x4,6d
2200020			6	1,2	W2x4,6d
12V					
2200030			12	0,4	W2x4,6d
2200040			12	1	W2x4,6d
2200050	W1,2W		12	1,2	W2x4,6d
2200060	W1,2W	FROSTED	12	1,2	W2x4,6d
2200070	W1,2W	BLUE	12	1,2	W2x4,6d
2200075	W1,5W		12	1,5	W2x4,6d
2200080	W2W		12	2	W2x4,6d
2200090	W2W	BLUE	12	2	W2x4,6d
2200100	W2,3W		12	2,3	W2x4,6d
24V					
2200110			24	0,75	W2x4,6d
2200120	W1,2W		24	1	W2x4,6d
2200130	W1,2W		24	1,2	W2x4,6d
2200140	W2W	BLUE	24	1,2	W2x4,6d
2200150	W2W		24	2	W2x4,6d
2200160		BLUE	24	2	W2x4,6d



W2

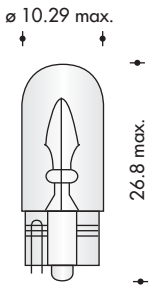

Art.nr.	Type	Description	Volt	Watt	Base
WEDGE BASE W2,1 x 9,5d T10					T - 10,29 x 26,8 mm
Inside Illumination / Dashboard lamp					
6V					
2300010			6,3	1	W2,1x9,5d
2300020			6	1,2	W2,1x9,5d
2300030			6	2	W2,1x9,5d
2301910	W3W		6	3	W2,1x9,5d
2302010	W5W		6	5	W2,1x9,5d
12V					
2300610	W1,2W		12	1,2	W2,1x9,5d
2300070	W1,2W	BLUE	12	1,2	W2,1x9,5d
2300410			12	2	W2,1x9,5d
2300080		BLUE	12	2	W2,1x9,5d
2300110	W3W		12	3	W2,1x9,5d
2300210	W5W		12	5	W2,1x9,5d
2300215	W10W		12	10	W2,1x9,5d
2300100	W5W	RED	12	5	W2,1x9,5d
2301710	WY5W	AMBER	12	5	W2,1x9,5d
2300120	W5W LL	LONG LIFE	12	5	W2,1x9,5d
2300130		XENON GAS FILLED	12	6	W2,1x9,5d
2301711			12	6	W2,1x9,5d
2301712			12	7,5	W2,1x9,5d
2301713			12	10	W2,1x9,5d
2301714		AMBER	12	10	W2,1x9,5d
2301715	W16W		12	16	W2,1x9,5d
24V					
2300509			24	2	W2,1x9,5d
2300510	W3W		24	3	W2,1x9,5d
2300310	W5W		24	5	W2,1x9,5d
2301810	WY5W	AMBER	24	5	W2,1x9,5d
2300140			24	2	W2,1x9,5d
2300150		BLUE	24	2	W2,1x9,5d



W2,1



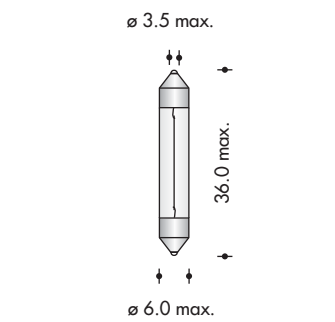
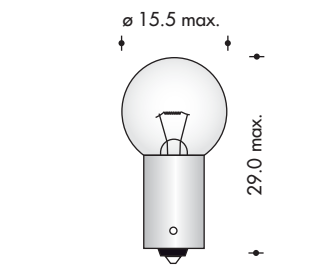
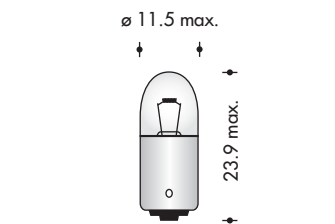
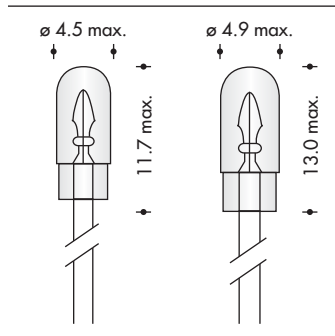

Art.nr.	Type	Description	Volt	Watt	Base
WIRE ENDED LAMP					
12V					
2600005		T-4,5 x 11,7 mm	12	0,8	T4,5
2600010		T-4,7 x 13,0 mm	12	1,0	T4,7
14V					
2600015		T-4,5 x 11,7 mm	14	1,1	T4,5
28V					
2600020		T-4,9 x 13,0 mm	28	1,1	T4,9
INTERIOR ILLUMINATION LAMP BA9s G-11					
					11,5 x 23,9 mm
6V					
0601510			6	3	BA9s
12V					
0603210			12	2,2	BA9s
0603510			12	3	BA9s
24V					
0605710			24	2,8	BA9s
0606110			24	3	BA9s
INTERIOR ILLUMINATION LAMP BA9s G-15					
					15,5 x 29,0 mm
6V					
0602010			6	5	BA9s
0602210			6	8	BA9s
12V					
0603610			12	3	BA9s
0604210	T5W		12	5	BA9s
0600020			12	6	BA9s
0600030			12	7,5	BA9s
0600040			12	10	BA9s
24V					
0608010			24	3	BA9s
0607710			24	5	BA9s
0600050			24	6	BA9s
FESTOON LAMP SV6					
					6,0 x 36,0 mm
Interior Illumination / Numberplate / Tail					
6V					
0400410			6	3	SV6
0400420			6	5	SV6
12V					
0400430			12	3	SV6
0400440			12	5	SV6
0400450			12	8	SV6
24V					
0400460			24	2	SV6
0400470			24	3	SV6
0400480			24	5	SV6



BA9s



BA9s



SV6

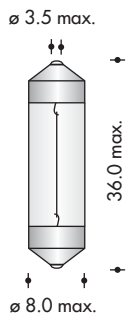

Art.nr.	Type	Description	Volt	Watt	Base
FESTOON LAMP SV7					8,0 x 36,0 mm
Interior illumination / Numberplate / Tail					
6V					
0400315			6	3	SV7
0400320			6	5	SV7
12V					
0400330			12	3	SV7
0400340			12	5	SV7
24V					
0400350			24	2	SV7
0400360			24	3	SV7
0400370			24	5	SV7



SV7

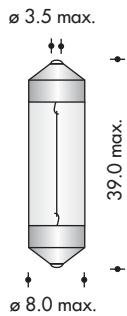

Art.nr.	Type	Description	Volt	Watt	Base
FESTOON LAMP SV7/8					8,0 x 39,0 mm
Interior illumination / Parking					
6V					
0400810			6	3	SV7/8
0401210			6	5	SV7/8
12V					
0402010	C3W		12	3	SV7/8
0402510			12	5	SV7/8
24V					
0402810			24	3	SV7/8



SV7/8

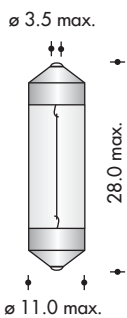

Art.nr.	Type	Description	Volt	Watt	Base
FESTOON LAMP SV8,5/8					11,0 x 28,0 mm
Interior illumination / Parking					
6V					
0400510			6	3	SV8,5/8
12V					
0401910	C3W		12	3	SV8,5/8
0401915			12	5	SV8,5/8
0502505			12	10	SV8,5/8
24V					
0404210			24	3	SV8,5/8
0502510	C10W		24	10	SV8,5/8



SV7/8

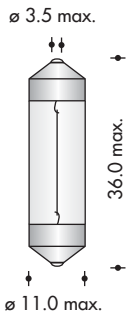

Art.nr.	Type	Description	Volt	Watt	Base
FESTOON LAMP SV8,5/8					11,0 x 36,0 mm
Interior illumination / Parking					
6V					
0400710			6	3	SV8,5/8
0401410	C5W		6	5	SV8,5/8
0500210			6	10	SV8,5/8
12V					
0402110	C3W		12	3	SV8,5/8
0402410	C5W		12	5	SV8,5/8
0501310	C10W		12	10	SV8,5/8
24V					
0403110	C3W		24	3	SV8,5/8
0403710	C5W		24	5	SV8,5/8
0404010			24	6	SV8,5/8
0502610	C10W		24	10	SV8,5/8



SV8.5/8

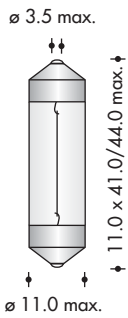

Art.nr.	Type	Description	Volt	Watt	Base
FESTOON LAMP SV8,5/8					11,0 x 41,0/44,0 mm
Interior illumination / Parking					
6V					
0500010			6	3	SV8,5/8
0401710	C5W		6	5	SV8,5/8
0500110			6	10	SV8,5/8
12V					
0500030			12	3	SV8,5/8
0402210	C5W		12	5	SV8,5/8
0501510	C10W		12	10	SV8,5/8
24V					
0500050	C3W		24	3	SV8,5/8
0404310	C5W		24	5	SV8,5/8
0502810	C10W		24	10	SV8,5/8
0500070			24	21	SV8,5/8
48V					
0500080			48	3	SV8,5/8
0500090			48	5	SV8,5/8



SV8.5/8



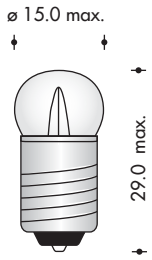

Art.nr.	Type	Description	Volt	Watt	Base
MOTORCYCLE AND BICYCLE HEADLAMP E10/13 G-15					15,0 x 29,0 mm
6V					
0801510			6	2,4	E10/13
0801810			6	2,4	EP10
0800020		YELLOW	6	2,4	E10/13
0801710			6	3	E10/13
0800040			6	4	E10/13
0802410			6	5	E10/13
0800050			6	6	E10/13
0800060			6	7,5	E10/13
0800070			6	10	E10/13



E10/E13

12V					
0800090			12	2	E10/13
0800100			12	3	E10/13
0800110			12	4	E10/13
0808410			12	2,2	E10/13
0804510			12	5	E10/13
0800120			12	6	E10/13
14V					
0800130			14	7	EP10
24V					
0800140			24	2	E10/13
0800150			24	3	E10/13
0805810			24	5	E10/13
0800160			24	7,5	E10/13

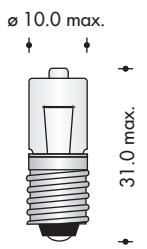

BICYCLE HEADLAMP HALOGEN E10/13					10,0 x 31,0 mm
6V					
0800210			6	2,4	E10/13



E10

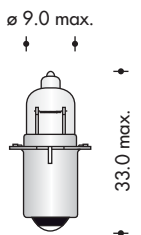

MOPED HEADLAMP HALOGEN PX13,5s					9,0 x 33,0 mm
6V					
0800200			6	2,4	PX13,5s
0800205			6	3	PX13,5s
0800206			6	6	PX13,5s
0800220			6	15	PX13,5s
12V					
0800230	HS2		12	15	PX13,5s



PX13.5s

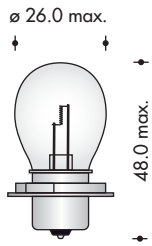

Art.nr.	Type	Description	Volt	Watt	Base
MOTORCYCLE LAMP P26s					26,0 x 48,0 mm
Single filament					
6V					
1101510	S3		6	15	P26s
1100010	S3	YELLOW	6	15	P26s
1100020			6	18	P26s
1100030		YELLOW	6	18	P26s
1101910			6	20	P26s
1100040		YELLOW	6	20	P26s
1100050			6	25	P26s
1100060			6	35	P26s



P26s

12V					
1104010	S3		12	15	P26s
1100070			12	18	P26s
1100080			12	20	P26s
1100090			12	25	P26s
1100100			12	35	P26s

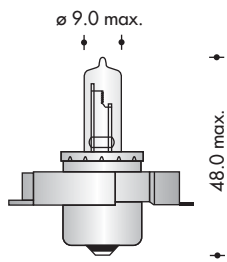

MOTORBIKE AND MOTORCYCLE HEADLAMP HALOGEN P26s					9,0 x 48,0 mm
6V					
1100110	S3		6	15	P26s
12V					
1100120	S3		12	15	P26s
1100125	S3		12	20	P26s



P26s

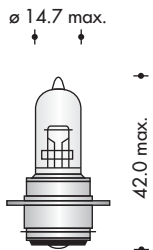

MOTORCYCLE HALOGEN HEADLAMP P36t					17,0 x 92,0 mm
Double filament					
6V					
6300010	M5		6	25-25	P36t
6300020	M5		6	35-35	P36t



P36t

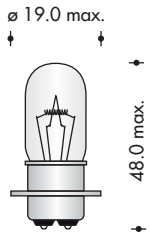

Art.nr.	Type	Description	Volt	Watt	Base
MOTOR AND MOTORCYCLE LAMP PX15d					19,0 x 48,0 mm
Double filament					
6V					
3300010			6	15-15	PX15d
3300020			6	20-20	PX15d
3300030			6	25-25	PX15d
3300040			6	35-35	PX15d
12V					
3300050			12	15-15	PX15d
3300060			12	20-20	PX15d
3300070			12	25-25	PX15d
3300080			12	35-35	PX15d



PX15d

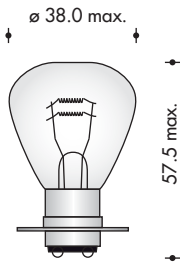

Art.nr.	Type	Description	Volt	Watt	Base
MOTOR AND MOTORCYCLE HEADLIGHT LAMP P15d					38,0 x 57,5 mm
Double filament					
6V					
3400010			6	15-15	P15d
3400020			6	20-20	P15d
3400030			6	25-25	P15d
3400040			6	35-35	P15d
12V					
3400050			12	15-15	P15d
3400060			12	20-20	P15d
3400070			12	25-25	P15d
3400080			12	35-35	P15d
3400090			12	45-45	P15d



P15d

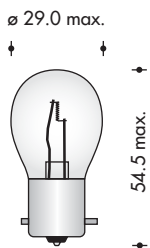

Art.nr.	Type	Description	Volt	Watt	Base
MOTOR AND MOTORCYCLE HEADLIGHT LAMP BAX15d					29,0 x 54,5 mm
6V					
0810010			6	15-15	BAX15d
0810020			6	18-18	BAX15d
0810030			6	20-20	BAX15d
0810040			6	25-25	BAX15d
0810050			6	35-35	BAX15d
12V					
0810060			12	15-15	BAX15d
0810070			12	18-18	BAX15d
0810080			12	20-20	BAX15d
0810090			12	25-25	BAX15d
0810100			12	35-35	BAX15d



BAX15d



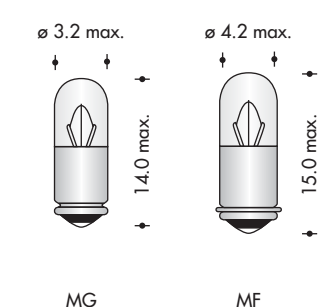
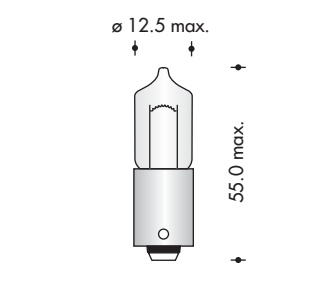
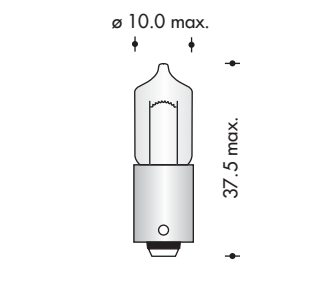
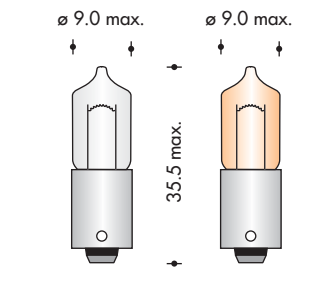
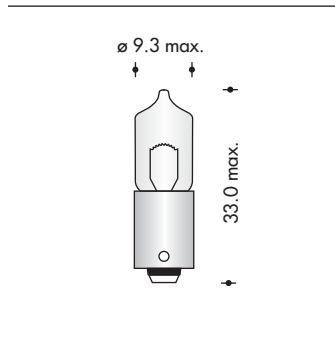

Art.nr.	Type	Description	Volt	Watt	Base
HALOGEN STOP/REAR AND FLASHERLAMP BA9s					9,3 x 33,0 mm
Miniwatt Lamps					
12V					
3600010			12	5	BA9s
3600020			12	10	BA9s
3600030			12	15	BA9s
3600040			12	20	BA9s
24V					
3600050			24	5	BA9s
3600060			24	10	BA9s
HALOGEN STOP/REAR AND FLASHERLAMP BAX9s BAY9s					9,0 x 35,5 mm
12V					
3700010	H6W		12	6	BAX9s
3700015	H6W	LONG LIFE	12	6	BAX9s
3700020	H21W		12	21	BAY9s
3700025	H21W	LONG LIFE	12	21	BAY9s
3700026	H21W	AMBER	12	21	BAY9s
24V					
3700030	H21W		24	21	BAY9s
3700040	H21W	AMBER	24	21	BAY9s
HALOGEN STOP/REAR AND FLASHERLAMP BA15s					10,0 x 37,5 mm
12V					
3800010	R5W		12	5	BA15s
3800020	R10W		12	10	BA15s
3800030			12	15	BA15s
3800040			12	20	BA15s
24V					
3800050	R5W		24	5	BA15s
3800060	R10W		24	10	BA15s
3800070			24	15	BA15s
3800080			24	20	BA15s
HALOGEN STOP/REAR and FLASHERLAMP BA15s					12,5 x 55,0 mm
3900010			12	50	BA15s
DISTANCE KEY LAMP					
1,35V - 100mA LENS					3,2 x 14,0 mm
9100010	T1 1/4				MGT1
1,35V - 100mA LENS					4,2 x 15,0 mm
9100020	T1				MFT



BA9s



BAX9s



BAY9s



BA15s



BA15s



MG



MF



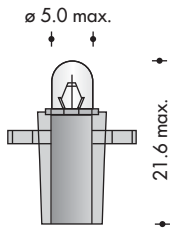

Art.nr.	Type	Description	Volt	Watt	Base
WEDGE BASE LAMPS WITH PLASTIC SOCKET B8,3d					5,0 x 21,6 mm
12V					
5100010		BLACK	12	1,20	B8,3d
5100020		WHITE	12	2,00	B8,3d
5100040		GREY	12	1,20	B8,3d
5100050		WHITE	12	2,00	B8,3d
24V					
5100030		GREY	24	1,20	B8,3d



B8.3d

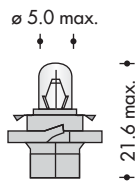

WEDGE BASE LAMPS WITH PLASTIC SOCKET B8,5d					5,0 x 21,6 mm
12V					
5100060		BLUE	12	1,00	B8,5d
5100070		BLACK	12	1,20	B8,5d
5100080		GREEN	12	2,00	B8,5d
24V					
5100090		GREY	24	1,20	B8,5d



B8.5d

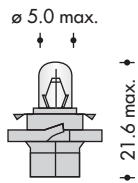

WEDGE BASE LAMPS WITH PLASTIC SOCKET BX8,5d					5,0 x 21,6 mm
12V					
5100095		PURPLE/LILAC	12	0,40	BX8,5d
5100100		ORANGE	12	1,00	BX8,5d
5100110		WHITE	12	1,12	BX8,5d
5100120		LIGHT BLUE	12	1,20	BX8,5d
5100125		ORANGE	12	1,5	BX8,5d
5100130		GREEN	12	2,00	BX8,5d
24V					
5100140		ORANGE	24	1,20	BX8,5d



BX8.5d

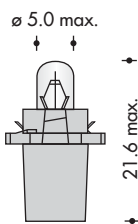

WEDGE BASE LAMPS WITH PLASTIC SOCKET B8,7d					5,0 x 21,6 mm
12V					
5100150		GREY	12	1,20	B8,7d
5100160		GREEN	12	2,00	B8,7d
24V					
5100170		BROWN	24	1,20	B8,7d



B8.7d

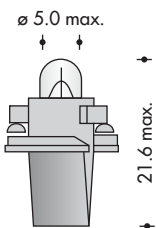

WEDGE BASE LAMPS WITH PLASTIC SOCKET BAX10d					5,0 x 21,6 mm
12V					
5100180		BROWN	12	1,50	BAX10d
5100190		GREEN	12	2,00	BAX10d
24V					
5100200		BEIGE	24-28	1,20	BAX10d
5100220		GREY	24	1,20	BAX10d



BAX10d

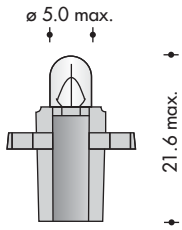

Art.nr.	Type	Description	Volt	Watt	Base
WEDGE BASE LAMPS WITH PLASTIC SOCKET BAX10s / BAX10y					5,0 x 21,6 mm
12V					
5100221		BLUE	12	2,00	BAX10s
12V					
5100222		BLACK	12	1,00	BAX10y
5100223		BLACK	12	1,20	BAX10y
5100227		GREY	12	2,00	BAX10y
24V					
5100224		BLUE	24	1,00	BAX10y
5100226		BLACK	24	1,20	BAX10y



BAX10s



BAX10y

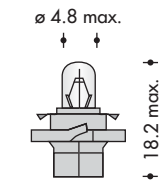

WEDGE BASE LAMPS WITH PLASTIC SOCKET BAX8,4d					4,8 x 18,2 mm
28V					
5100225		DARK RED	28	2,00	BAX8,4d



BAX8,4d

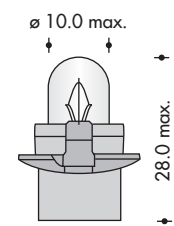

WEDGE BASE LAMPS WITH PLASTIC SOCKET B12,3d					10,0 x 28,0 mm
12V					
5100230		WHITE	12	2,00	B12,3d
5100235		WHITE	12	2,00	B12,3d



B12,3d

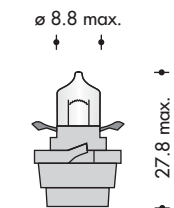

WEDGE BASE LAMPS WITH PLASTIC SOCKET B10d					8,8 x 27,8 mm
12V					
5100240		RED	12	3,00	B10d
5100250		BLACK	12	5,00	B10d



B10d

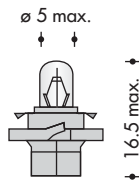
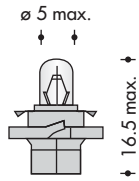

Art.nr.	Type	Description	Volt	Watt	Base
WEDGE BASE LAMPS WITH PLASTIC SOCKET B8,4d					5,0 x 16,5 mm
12V					
5100255		GREEN	12	1,30	B8,4d
5100260		BLUE	12	1,20	B8,4d
5100270		PINK	12	1,12	B8,4d
5100280		BLUE	12	1,80	B8,4d
5100290		WHITE/GREEN	12	2,00	B8,4d



B8.4d

WEDGE BASE LAMPS WITH PLASTIC SOCKET BX8,4d					5,0 x 16,5 mm
12V					
5100300		BLACK	12	1,20	BX8,4d
5100310		ORANGE	12	1,12	BX8,4d
5100315		BEIGE	12	1,30	BX8,4d
5100320		WHITE	12	1,50	BX8,4d
5100330		BLUE	12	1,80	BX8,4d
5100340		GREEN	12	2,00	BX8,4d
24V					
5100345		GREEN	24	1,20	BX8,4d
5100346		RED	24	1,50	BX8,4d



BX8.4d



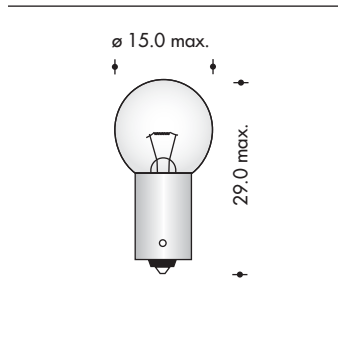

Art.nr.	Type	Description	Volt	Watt	Base
FORK LIFT LAMP BA9S					G - 15,0 x 29,0 mm
48V					
9000010			48	2,5	Ba9s
9000020			48	3,4	Ba9s
9000030			48	5	Ba9s



BA9s

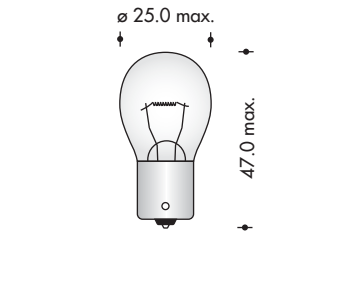

FORK LIFT LAMP BA15s					
					S - 25,0 x 47,0 mm
48V					
9000040			48	8	BA15s
9000050			48	10	BA15s
9000060			48	25	BA15s
9000090			48	35	BA15s
9000070			48	45	BA15s



BA15s

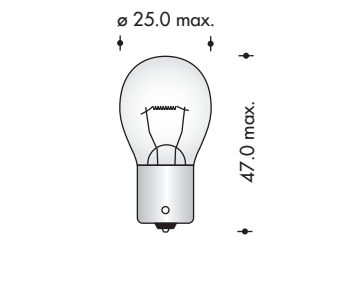

FORK LIFT LAMP BA15d					
					S - 25,0 x 47,0 mm
48V					
9000105			48	25	BA15d



BA15d

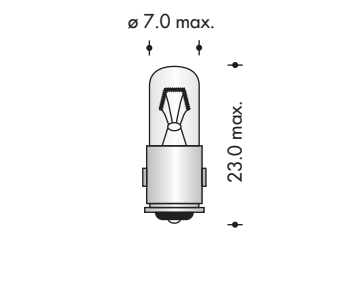

FORK LIFT LAMP BA7s					
					T - 7,0 x 23,0 mm
48V					
9000110			48	2	BA7s



BA7s

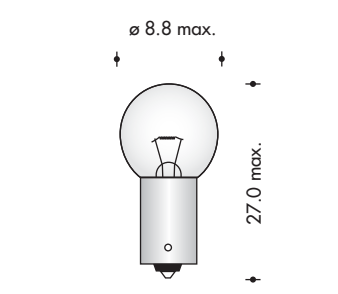

FORK LIFT LAMP BA9s					
					T - 8,8 x 27,0 mm
48V					
9000120			48	2,5	BA9s
9000130			48	3,4	BA9s
9000140			48	5	BA9s



BA9s

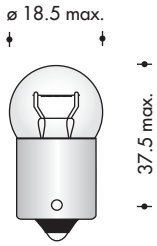

Art.nr.	Type	Description	Volt	Watt	Base
FORK LIFT LAMP BA15s					G - 18,5 x 37,5 mm
12V					
9000150			12	12	BA15s
24V					
9000160	R10W		24	10	BA15s
48V					
9000170			48	8	BA15s
9000180			48	10	BA15s



BA15s

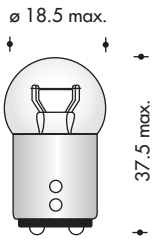

FORK LIFT LAMP BAY15d					G - 18,5 x 37,5 mm
48V					
9000190			48	8	BAY15d
9000200			48	10	BAY15d
9000210			48	25	BAY15d



BAY15d

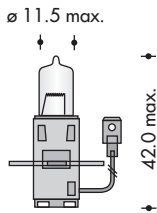

FORK LIFT LAMP PK22s					11,5 x 42,0 mm
36V					
9000220			36	45	PK22s
48V					
9000230			48	45	PK22s
80V					
9000235			80	55	PK22s



PK22s

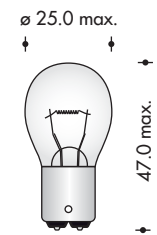

FORK LIFT LAMP BAY15d					S - 25,0 x 47,0 mm
48V					
9000240	S25		48	23-8	BAY15d
9000250	S25		48	25-10	BAY15d
9000260	S25		48	8	BAY15d
9000270	S25		48	10	BAY15d
9000280	S25		48	25	BAY15d



BAY15d

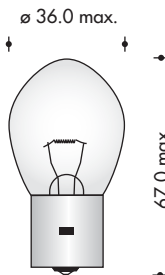

FORK LIFT LAMP BA20s					36,0 x 67,0 mm
48V					
9000290			48	25	BA20s
9000300			48	35	BA20s



BA20s

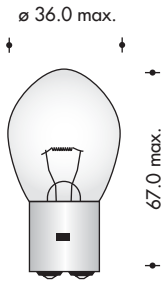
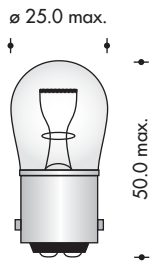

Art.nr.	Type	Description	Volt	Watt	Base
FORK LIFT LAMP BA20d					S - 25,0 x 50,0 mm
24V					
9000310	S25		24	25	BA20d
48V					
9000315	S25		48	25	BA20d
9000320	S25		48	35	BA20d
9000330	S25		48	48	BA20d



BA20d

Art.nr.	Type	Description	Volt	Watt	Base
FORK LIFT LAMP BA20d					36,0 x 67,0 mm
80V					
9000340			80	10	BA20d
9000350			80	25	BA20d



BA20d





Art.nr.	Type	Description	Volt	Watt	Base
SPARE KITS AUTOMOTIVE LAMP					
NORM STANDARD ECE R37					
9500010		KIT TYPE CAT1			
	12V	45-40W	P45t	1 piece	R2
	12V	21-5W	Bay15d	1 piece	P21/5W
	12V	21W	Ba15s	2 pieces	P21W
	12V	5W	SV 8,5	1 piece	C5W
	12V	4W	Ba9s	1 piece	TW4
		Ceramic Fuse 5A		1 piece	YELLOW
		Ceramic Fuse 8A		2 pieces	WHITE
		Ceramic Fuse 15A		1 piece	RED



Art.nr.	Type	Description	Volt	Watt	Base
SPARE KITS AUTOMOTIVE LAMP					
NORM STANDARD ECE R37					
9500020		KIT TYPE CAT2			
	12V	45-40W	P45t	1 piece	R2
	12V	21-5W	Bay15d	1 piece	P21/5W
	12V	21W	Ba15s	1 piece	P21W
	12V	5W	Ba15s	1 piece	R5W
	12V	5W	SV 8,5	1 piece	C5W
	12V	4W	Ba9s	1 piece	TW4
		Ceramic Fuse 5A		1 piece	YELLOW
		Ceramic Fuse 8A		1 piece	WHITE
		Ceramic Fuse 15A		1 piece	RED



Art.nr.	Type	Description	Volt	Watt	Base
SPARE KITS AUTOMOTIVE LAMP					
NORM STANDARD ECE R37					
9500030		KIT TYPE CAT3			
	12V	45-40W	P45t	1 piece	R2
	12V	21-5W	Bay15d	1 piece	P21/5W
	12V	21W	Ba15s	1 piece	P21W
	12V	21W AMBER	Bau15s	1 piece	PY21W
	12V	5W	SV 8,5	1 piece	C5W
	12V	4W	Ba9s	1 piece	TW4
		Flat Fuse 7,5A		1 piece	BROWN
		Flat Fuse 10A		1 piece	RED
		Flat Fuse 15A		2 pieces	BLUE
		Flat Fuse 20A		1 piece	YELLOW



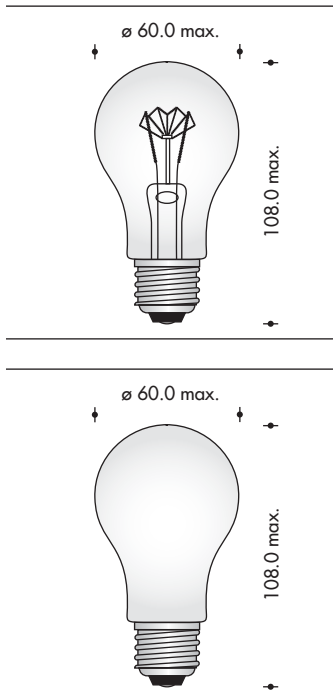

Art.nr.	Type	Description	Volt	Watt	Base
WORK LAMPS (for garages) RC - reinforced construction Shock proof GLS					60,0 x 108,0 mm
12V					
2996027RC	CLEAR		12	40	E27
3026027RC	FROSTED		12	40	E27
3006027RC	CLEAR		12	60	E27
3036027RC	FROSTED		12	60	E27
24V					
4596027RC	CLEAR		24-28	40	E27
4566027RC	FROSTED		24-28	40	E27
4606027RC	CLEAR		24-28	60	E27
4576027RC	FROSTED		24-28	60	E27
42V					
6636027RC	CLEAR		42	40	E27
6616027RC	FROSTED		42	40	E27
6646027RC	CLEAR		42	60	E27
6626027RC	FROSTED		42	60	E27
48-50V					
7976027RC	CLEAR		48-50	40	E27
7996027RC	FROSTED		48-50	40	E27
7986027RC	CLEAR		48-50	60	E27
7966027RC	FROSTED		48-50	60	E27
60-65V					
8536027RC	CLEAR		60-65	60	E27
8526027RC	FROSTED		60-65	60	E27
8546027RC	CLEAR		60-65	60	E27
8556027RC	FROSTED		60-65	60	E27
110-130V					
8686027RC	CLEAR		110-130	40	E27
8696027RC	FROSTED		110-130	40	E27
8716027RC	CLEAR		110-130	60	E27
8726027RC	FROSTED		110-130	60	E27
8736027RC	CLEAR		110-130	100	E27
8746027RC	CLEAR		110-130	200	E27
220-240V					
125230RC	CLEAR		220-240	40	E27
125030RC	FROSTED		220-240	40	E27
125240RC	CLEAR		220-240	60	E27
125040RC	FROSTED		220-240	60	E27
125250RC	CLEAR		220-240	75	E27
125050RC	FROSTED		220-240	75	E27
125260RC	CLEAR		220-240	100	E27
125060RC	FROSTED		220-240	100	E27



E27



	Art.nr.	Type	Description	Volt	Watt	Base



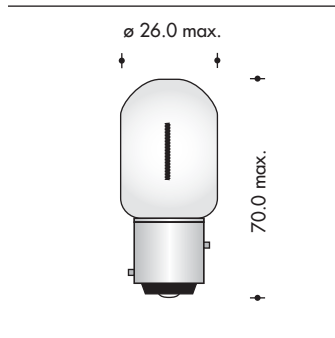

Art.nr.	Type	Description	Volt	Watt	Base
BOAT AND NAVIGATION LAMP BAY15d					26,0 x 70,0 mm
12V					
3853010	12-20 CD		12	10	BAY15d
3853020	30 CD		12	25	BAY15d
24V					
3853030	12-20 CD		24	10	BAY15d
3853040	40 CD		24	25	BAY15d
28V					
3853050	40 CD		28	25	BAY15d
110V					
3853060	40 CD		110	25	BAY15d
220V					
3853070	40 CD		220	25	BAY15d



BAY15d

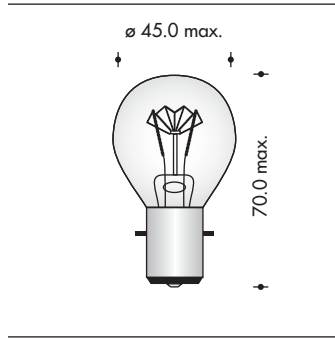

BOAT AND NAVIGATION LAMP BAY15d					45,0 x 70,0 mm
220V					
3853080	40 CD		220	25	BAY15d



BAY15d

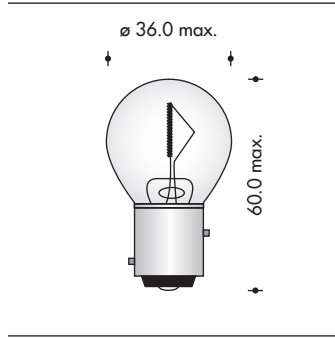

BOAT AND NAVIGATION LAMP BAY15d					36,0 x 60,0 mm
12V					
3853090			12	10	BAY15d
3853100			12	25	BAY15d



BAY15d

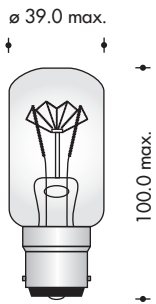

Art.nr.	Type	Description	Volt	Watt	Base
BOAT AND NAVIGATION LAMP BA22d					39,0 x 100,0 mm
24V					
9503028	13 CD		24	40	BA22d
9513028	26 CD		24	60	BA22d
9523028	35 CD		24	55	BA22d
9533028	65 CD		24	80	BA22d
110V					
9543028	13 CD		110	40	BA22d
9553028	26 CD		110	60	BA22d
9563028	65 CD		110	80	BA22d
220V					
9573028	13 CD		220	40	BA22d
9583028	26 CD		220	60	BA22d
9593028	65 CD		220	80	BA22d



BA22d



Art.nr.	Type	Description	Volt	Watt	Base
BOAT AND NAVIGATION LAMP E27					39,0 x 100,0 mm
24V					
9603028	13 CD		24	40	E27
9613028	26 CD		24	60	E27
110V					
9623028	13 CD		110	40	E27
9633028	26 CD		110	60	E27
9643028	65 CD		110	80	E27
220V					
9653028	13 CD		220	40	E27
9663028	26 CD		220	60	E27
9673028	65 CD		220	80	E27



E27

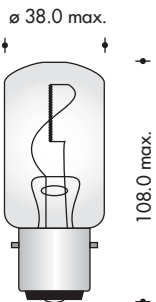

Art.nr.	Type	Description	Volt	Watt	Base
BOAT AND NAVIGATION LAMP P28s					38,0 x 108,0 mm
24V					
9683028	60 CD		24	40	P28s
48V					
9693028	60 CD		48	65	P28s
110V					
9703028	50 CD		110	60	P28s
115V					
9713028	50 CD		115	60	P28s
220V					
9723028	50 CD		220	65	P28s
230V					
9733028	50 CD		230	65	P28s



P28s



	Art.nr.	Type	Description	Volt	Watt	Base
<hr/>						
<hr/>						



Disclaimer & Copyright© Notice

All text, logos and designs are copyright of Ormalight. All content (images, drawings, photos, descriptions, graphics, ...) are sole copyright of Ormalight ® and consequently may not be partly or entirely copied, reproduced, duplicated, downloaded, projected, stored, edited or used in any way without our prior written permission.

Catalogue by Ormalight®
© may 2017